

Assembly Instructions BR 13x -2

Box kits



MA13X2.ENG_012024

Always read through these instructions, completely and carefully, before you start the assembly work.



Table of contents

1. Safety Instructions and Warnings	2
1.1 Checking the kit contents	2
1.2 Warnings	2
1.3 Safety instructions	3
1.4 Copyright	3
2. Preparatory work / Personnel requirements	4
2.1 Personnel requirements, preparations	4
2.2 Required tools and equipment	4
2.3 Tightening torques for screws and bolts	4
3. Assembling the Kit	5
3.1 Installing the walls	5
3.2 Installing the frame crossmember	5
3.3 Attaching and fastening the roof	6
3.4 Wiring the body	6
3.5 Installing the frame, doors, top gate, roller shutters	7
3.6 Attaching the rear roof corners and sealing the kit	7
3.7 Fixing the insulated floor onto the chassis	8
3.8 Installing the box body on the subframe	9
4. Finishing work	10
5. Maintenance, service, spare parts	11
6. Disposal of old box bodies and components	11
7. Kit contents	12

1. Safety Instructions and Warnings



These instructions explain how to assemble the kits 133-2 to 139-2. To create a fault-free body always follow the work instructions described here, in particular, the following warnings, otherwise the warranty is voided. Coloured representations serve for illustration purposes only. **Get in touch with us immediately in case of uncertainties.**

1.1 Checking the kit contents

- **Check the delivery against the enclosed packing list for completeness.** Notify the delivering carrier immediately of any transport damage. Please understand that we must reserve the right to make changes to the design, features and technology delivered. The general kit contents are listed on page 12.







1.2 Warnings

AluTeam generally does not know the precise intended purpose of the kit. **You, as the body builder, must co-ordinate the order and processing of the kit to the requirements of your customer and to the body guidelines of the chassis manufacturers.** This also applies to materials used and surface finishes. Damage due to transport goods such as aggressive chemicals are not a reason for complaint.

- Store the kit in a dry and clean place (not outdoors).
- To ensure that (spray) water cannot penetrate the body, the sealing cords in the sections must not show any signs of damage.
- The contact surfaces of the assemblies must be free from contamination and dirt.



tightening torque too high

		
<i>suspended loads on the crane</i>	<i>falling objects</i>	<i>toppling parts or assemblies</i>
		
<i>risk due to high-pressure cleaners</i>	<i>dangerous substances</i>	<i>crushing hazards</i>

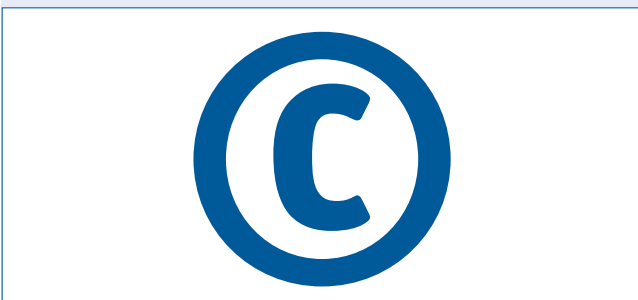
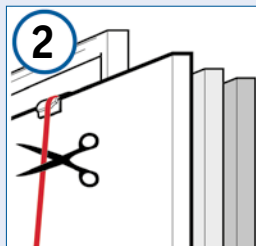
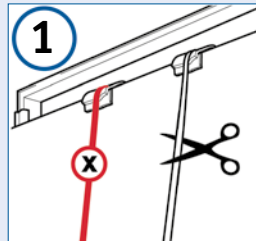

- Carry out the fastenings between the longitudinal chassis beams and the chassis frame as described in the body guidelines of the respective body builder (*see also 3.8.*). **At least the two front fastenings must be spring-mounted.** Otherwise, forces that occur during driving, e.g. in case of cornering, load changes or non-uniform loading, are transferred onto the body and can cause cracks in the body structure.
- Never position screws or bolts at an angle, they must not tilt. **Note the torques** (2.3). A torque lower than specified weakens the strength of the system, a significant exceedance can cause damage to components!
- Connect the components directly using the screws supplied. These may only be used once. Third party or used screws or bolts endanger operational safety. **Always use new AluTeam screws and bolts** even for repairs.

1.3 Safety instructions

Pay attention to your own safety and to that of your employees. Working with kits involves hazards. Therefore, caution is always necessary, in particular, you should definitely:

- ... use a lifting beam and always wear a helmet to unload or transport the packed kit with a crane. Always lift assemblies vertically at their centre of gravity and not at an angle. Never step under raised loads.
- ... secure the kit against tilting, tipping and toppling when unloading/transporting the packed kit with a forklift truck.
- ... Place transport racks only on level surfaces and secure them against inclination, tilting, toppling.
- ... remove all packing straps in the specified order during assembly, remove the white packing straps first. The individual components and assemblies are held by a red packing strap. Secure the part to be removed against toppling before cutting the packing strap.
- ... if using an assembly dolly, secure it against rolling away.
- ... if you lift the floor using the airline rails, use at least 2 double-stud fittings with sufficient load-bearing capacity.
- ... lift the roof with a lifting beam or vacuum lifter only! The mounting strips (airline rails) are used for this as an assembly aid only. They must not be used to lift assembled box bodies. **Risk of pulling out!**
- ... comply with all relevant legal requirements in your country, such as laws, regulations, etc. regarding road traffic and goods transport, as well as all relevant occupational health and safety regulations. This is the responsibility of the body builder.
- ... when cleaning and sealing, ensure adequate ventilation and following the use, safety and disposal instructions of the adhesive / sealant manufacturers. Request the safety sheet and the instructions for use from the manufacturer as printed on the cartridge or contact **+49 (0)521 4173 -1110.**

1.4 Copyright

AluTeam holds the copyright to these instructions. They are intended for the assembly company and its personnel and may not, neither as a whole nor in part, be:

- reproduced
- distributed or
- otherwise disclosed.

Infringements can result in civil and criminal charges!

2. Preparatory work / Personnel requirements

AluTeam kits can be assembled in any well-equipped workshop! Carry out the following preparations beforehand:



2.1 Personnel requirements, preparations

For the assembly of box kits 133-2 to 139-2 1-2, fitters are required with training as vehicle or body builders or equivalent.

- Check that the delivery and order match (1.1)
- Secure the overall kit as well as the individual assemblies against toppling. Store the latter on the pallet in the order required for assembling the body. Do not cut the red straps, which secure a component, until you need to remove the component (see 1.2!).
- Provide **sufficient free space** (at least 3 m) at the sides and behind the vehicle as well as the **tools and equipment** (2.2) .
- In case of "Latt um Latt" (batten by batten) kits, remove the bottom 2 - 3 rows of battens, in order to be able to lay the floor properly and easily.
- The ambient temperature for components as well as adhesives and sealants must be at least 15°C.

Attention: The final strength of the sealant is reached after 24 hours at 20°C.

2.2 Required tools and equipment

Before starting the assembly, make sure the following equipment is to hand:

- Measuring tape
- Precision cordless screwdriver with torque setting (e.g. Fein Accutec ASM12-12)
- Power screwdriver bit Tx 30 to DIN 3126 / ISO 1173, extra hard type 1/4" drive, min. 70 mm long (AluTeam Article No. MH 170107)
- An extension for screwdriver bits may be useful
- Torque wrench up to 200 Nm,
- Hexagon sockets size 6 and 8
- Pneumatic or manual dispenser gun for 310 mL sealant cartridges
- 2 Single-stud fittings (LoadLok 5018 or allsafe JUNGFALK 7105/75018)
- Rivet gun for rivet diameter 5 mm
- 4 wooden panels appr. 300x300 mm (min. 20 mm thick) or similar
- Crane with at least 1 tonne working load limit and vacuum lifting beam or lifting gear are recommended
- Punch d = 3 mm and d = 4 mm
- 2 standing ladders or scaffold unit
- HSS drill bit Ø 5.0 mm
- a proprietary painter's painter's spatula (blade approx. 50 mm wide)

2.3 Tightening torques for screws and bolts

The settings for the screws and bolts must be checked using appropriate measuring equipment. The torques apply to a dry thread. **Set the following torque:**

- for the assembly screw M 6 x 21 (MD100224) 10 Nm ± 1 Nm
- for the countersunk screw M 10 x 8 (MD100329) 52 Nm ± 5 Nm
- for the frame screw M 10 x 60 (MD100328) 72 Nm ± 5 Nm
- for the subframe screw M 12 x 45 80 Nm ± 5 Nm
- for the fine thread screw M 12 x 45 85 Nm ± 5 Nm

3. Assembling the kit



- Carry out the assembly on a level floor. To protect the painted components and to make alignment easier, place e.g. wooden panels 300 x 300 mm (at least 20 mm thick) or similar on the floor under the corners. The corner pillars may not be closed off from below, as you may have to lay cables here later.
- If a body has an insulated floor, you can carry out the assembly directly on the floor. To be accessible all round, it must be raised, e.g. supported on double-pallets (must not protrude), on trestles or assembly dollies. The floor must not sag, to ensure that the walls have full contact with the floor along their whole length.



3.1 Installing the walls

- Use the crane to remove the front wall from the transport unit, place it on boards or centred on the insulated floor and secure the wall against toppling.
 - If the floor is insulated, lay a sealing bead under the contact surface of the wall (see 2.9). Use the enclosed Spax screws to screw the wall onto the floor sections. The rear corner pillars must protrude 35 mm above the floor so that the frame crossmember can be positioned flush on the floor.
 - Remove the side wall, push it onto the front wall at right-angles and then put it down. Instead of the claws and lifting beams shown here for the crane work, you can also use a vacuum lifting beam as a very good alternative.
 - The side wall remains standing in the crane, one fitter secures the assemblies on the outside. The 2nd employee screws in 3 - 4 screws MD100224 (torque 10 Nm \pm 1) on the inside, starting from the bottom up to approx. $\frac{3}{4}$ of the box height, until the sections are pressed together. If necessary, use punches as an assembly aid.
- Tip:** For kits with interior wall panelling, we recommend using a bit extension, length approx. 100 mm, or a flexible bit holder.
- Position the second side wall in the same way and align it at right-angles with the front wall. The wall remains hanging from the crane initially. Starting from the bottom, screw in 3 - 4 screws MD100224 up to approx. $\frac{3}{4}$ of the box height until the sections are pressed together and the required torque (10 Nm \pm 1) is reached.

3.2 Installing the frame crossmembers

- Position the bottom frame crossmember supplied between the frame pillars.
- Fix the crossmember from the outside of the pillars with 2 screws M 10 x 60 mm each. Do not tighten the screws yet!
- Check, and correct if necessary, the angularity and diagonal dimensions of the parts assembled until now.



3.3 Attaching and fastening the roof

- If a kit includes doors, undo the lashing straps of the doors before attaching the roof. However, the doors must remain secured against turning.
- Place the roof in a horizontal position and hook the single-stud fittings into the roof assembly rails. The fittings must be tight!
- Clean the front roof caps on the inside with bond-activating cleaner and leave to flash-off and dry for approx. 5 minutes. Then apply a sealant on the inside sealing surfaces.
- If a kit includes a top tailgate, use assembly screws 6.3 x 22 mm (included in the material for the top gate) to fix it onto the roof flange using the holes provided in the hinge.

- Push the top frame gusset plates sideways into the top frame cross-members so that the pointed tip faces downwards. If kits include side lights, place them in the crossmember.

Fasten the gusset plates with 2 countersunk screws M 10 each. Tighten the screws only slightly.

- Use suitable lifting gear to lift the roof with a lifting beam at the single-stud fittings. Or use a vacuum lifting beam.
- Centre the roof on the top rail of the front wall. The roof caps grip over the corner pillars. Align the roof with the wall sections. Fix it on the front wall with 3 screws spread uniformly over the width.

Attention: the screws must not tilt.

- Do not yet lower the roof completely at the back, but instead leave approx. 10 - 15 cm clear space for the wiring. If the cable set is preassembled, **connect the connections as described in 3.4 and proceed as described there.**

- Lower the roof slowly so that the pointed tips of the frame gusset plates facing downwards centre in the frame pillars.

- Fix the gusset plates in the frame pillars with 3 M 10 countersunk screws MD100329 each positioned on each angle side (tighten finger-tight only!). In case of preassembled cable set, push the cable laid in the roof edge into the top pillar cutout when lowering the roof. Otherwise, there is a risk of crushing the cable.

- Screw 3 to 4 screws M6 (MD100224) into the side wall - roof joint, until the required torque 10 Nm \pm 1 Nm is reached.

3.4 Wiring the body

- The cable connections of the BR 13x-2 kits can be installed very easily as follows:
- To wire the side lights and the third brake light **only connect 1.** the connectors and push **2.** the plug-in connection (right) downwards into the right frame pillar.

Attention: The cables and connectors must not be crushed.

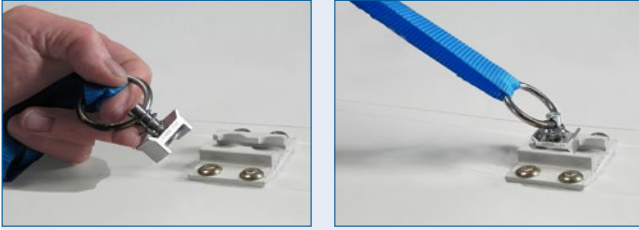

Treten Sie nie unter gehobene Lasten, heben Sie das Dach nur waagrecht, niemals schräg hängend an!

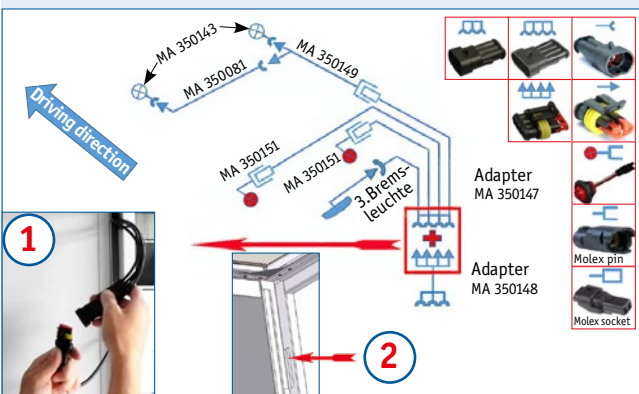
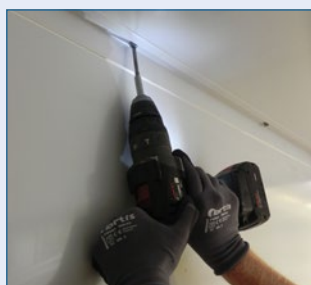

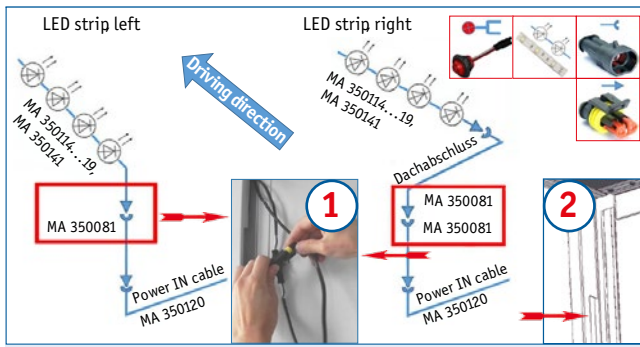

- To wire the LED strips with motion detectors (infrared sensor), fit together only **1.** the connectors and push **2.** the plug-in connection downwards into the left-hand frame pillar.

Note: The figure shows wiring with LED strips on the right and on the left-hand side.



3.5 Installing the frame, doors, top gate, roller shutters

- Fix the bottom crossmember from the outside of the corner pillars with 2 screws M 10 x 60 mm each. Do not tighten the screws yet! Measure the diagonals of the frame. Correct them if necessary until they match.
- Tighten the screws of the frame gusset plates M 10 x 20 (MD100332) and the bottom frame crossmember screws M 10 x 60 (MD100328) to the correct torque (do not use an impact wrench!). The crossmember and the rear surfaces of the pillars must be flush.
- Remove the fittings from the roof assembly rails.
- Close the rear doors to check the fit. If necessary – depending on the doortype – adjust them using the hitches on the frame crossmembers.
- Fix a top gate on the frame in the holes provided in the hinge using the screws MD100058. Then seal the crossovers. Latch the pneumatic springs (piston rod must face downwards) into the ball heads.
- If a frame pillar has an integrated seal, use the assembly screws **A** to secure the gate against moving sideways.
- If a frame pillar does not have an integrated seal, use 2 brackets **B** to secure the gate against moving sideways.
 - Install a roller shutter as described in the current instructions for roller shutters included in the assembly material.

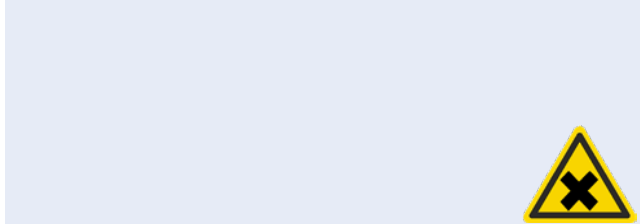
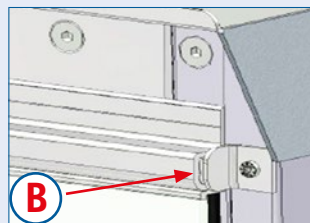
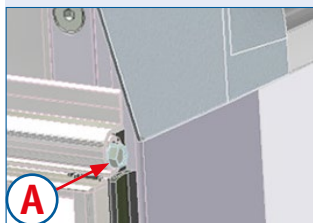
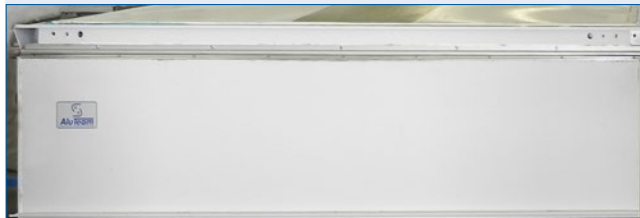

3.6 Attaching the rear roof corners and sealing the kit

- The ambient temperature for components as well as adhesives and sealants must be at least 15°C

Attention: The final strength of the sealant is reached after 24 hours at 20° C.

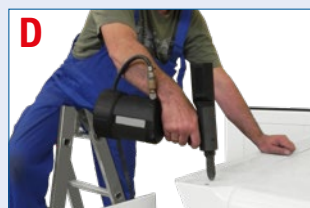

- Clean the sealing surfaces of the rear roof corners with the bond-activating cleaner. After approx. 5 min. flash-off time, apply sealing compound **C** on the (inside) contact surfaces.

- Place the corners on the roof. If necessary, drill through the roof corners and the frame crossmembers from above in the existing holes with a diameter of 5 mm. Please ensure that you do not damage any cables.

- Set **D** 2 blind rivets MD150051 d = 5 mm. Then remove the sealing compound that emerged at the corners.

- Use the bond-activating cleaner of the kit to clean the sealing surfaces **E**.



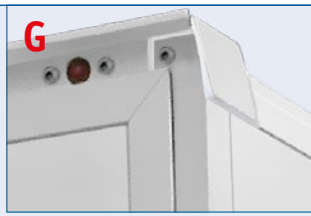

- After approx. 5 minutes flash-off time, use the sealant supplied to seal:
 - the front roof corners at the bottom **F**,
 - the rear roof corners all round **G**,
 - the connection of the roof edge and the frame pillar at the top end,
 - the contact areas at the top right and left from the frame pillar to the frame crossmember,
 - the rivets for fixing the roof corners from above
 - the vertical gap in the front wall between the bottom rail and the front corner pillars **H**.
- Seal an insulated floor from underneath at the bottom rail at the side and front and at the frame crossmember.
- Seal all seals only with smoothing agent or water without soap additives **I**.

3.7 Fixing the insulated floor onto the chassis

Use the enclosed assembly instructions for the subframes. We recommend that you assemble the subframe directly on the horizontally aligned and torsion-free chassis.

Follow the body and conversion guidelines of the respective body builder, in particular the positioning and type of subframe connection, flexible or stiff under shear. Possible adjustment work such as drill-holes must be carried out by the body builder and are not a cause for complaint.

- Align the longitudinal chassis beams on the chassis so that the bevel of the beam faces the front and the respective small top wing beam faces the outside. Fix the longitudinal chassis beams with screw clamps. The precise longitudinal position of the beams and thus the distance of the body from the driver's cab is defined by the body builder.

Depending on the vehicle type, you receive the following brackets:

- **Fixing bracket VS100068** on the two front fixing points of the chassis for: MB Sprinter 3.5t/5t; VW Crafter old 3.5t/5t
- **Fixing bracket VS100048** on the two front fixing points of the chassis for: VW Crafter new 3.5t/5t; MAN TGE 3.5t/5t

- **Fixing bracket VS100066 with clamping plate VS100067** at the 1st fixing point of the chassis for: Ford Transit / Opel Movano / Renault Master 2010

from the 3rd fixing point of the chassis for:
MB Sprinter 3.5t/5t; VW Crafter old 3.5t/5t

Attention: mount the clamping plate on the inside of the longitudinal beam using the supplied bolt, washer and nut.

- **Fixing bracket VS100115** above the rear axle in the offset area on the inside of the chassis for: VW Crafter new 5t / MAN TGE 5t
- **Fixing bracket VS100071** above the rear axle on the inside of the chassis for: VW Crafter new 5t / MAN TGE 5t
- **Fixing bracket VS100046** for the front area for: Iveco Daily (Eurocargo) / Mitsubishi Fuso Cante / DAF MAN TGL, TGM, TGS, TGX, TGA from 7.5t / MB Atego 7.5t / Renault Mascott, Maxity/ Nissan Cabster / Scania
- **Shear plate VS100089 in the axle area for** Iveco Daily (Eurocargo) / MAN 7.5t / DAF 7.5t / MB Atego 7.5t



Art No. VS100068

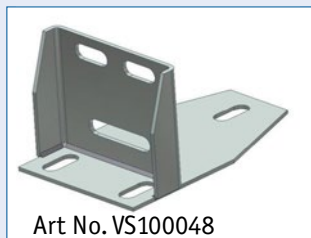

Art No. VS100048



Art No. VS100066



Art No. VS100067



Art No. VS100115



Art No. VS100071



Art No. VS100046



Art No. VS100089

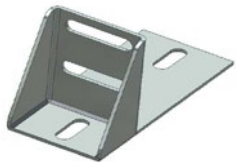

Art No. VS100072



Art No. VS100075



Art No. VS100079



Art No. VS100080



- **Fixing bracket VS100072 with clamping plate VS100075** throughout, from the first fixing point for: VW Crafter new 5t / MAN TGE 5t

- **Fixing bracket VS100079** above the rear axle on the inside of the chassis for: Citroen Jumper / Fiat Ducato / Peugeot Boxer

- **Fixing bracket VS100080** above the rear axle on the inside of the chassis for Renault Master 2010 / Opel Movano

- Mount the brackets on the longitudinal beam with 2 or 4 screws. Any holes required in the chassis longitudinal beams must be made according to the body guidelines of the body builder.
- Clean the underside of the floor in the area that sits on the longitudinal beams later.
- Lightly grind the top of the longitudinal beam.
- Clean the top of the aluminium longitudinal beam with the bond-activating cleaner supplied and apply a single component sealing compound.
- Lay the floor on the longitudinal beams and align it.
- Screw the floor onto the longitudinal beams using the clamping claws supplied and to the required torque.

3.8 Installing the box body on the subframe

- Position the subframe or chassis, aligned horizontally and torsion-free, on a level surface.
- Use the crane and a lifting aid to place the finished box body on the subframe or the chassis. Never lift the assembled box body by the roof eyebolts. **Risk of pulling out!**
- **In case of an insulated floor, lightly grind or roughen the top of the floor in the area of the wall support at the side and front.** Clean the contact surfaces of the section and floor with bond-activating cleaner. After 5 min. flash-off time:
 - apply a seal bead \varnothing 5 mm on the side and front of the top of the floor, approx. 15 mm from the outer edge and then position the walls immediately
 - screw the countersunk head Spax 5 x 40, MD100345 into the crossmember of the floor using the holes of the bottom rail or with not more than 350 mm screw spacings
- **If using an aluminium or steel subframe, rivet the box body and subframe as described in the drawing:**
 - In the case of kits with a sliding side door, whose installation space above the door frame is limited, always use a torque wrench (torque 10 Nm \pm 1) to connect the side wall to the roof.
 - In case of sliding side doors, always ensure free and easy movement of the vehicle wheels in the area of the runner. **Sliding side doors are not available for bodies with insulated floors.**
 - In the case of BR 137-2 kits, support the frame pillars in the direction opposite to the driving direction against the subframe or the subframe crossmembers, so that no deformations occur in case of ramp contact. The support must be provided so that forces are transferred into the subframe structure or the floor.

Seal bead \varnothing 5 mm

Spax 5x40,
MD100345

Fastening on the insulated floor

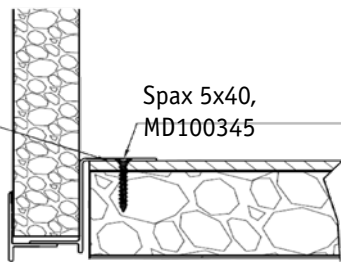

Rivet fixing, rivet \varnothing 6.5 mm
e.g. Avdel Hemlock 2221-0815

Note clamp length if using plain washer

Rivets are NOT included

Fastening on the steel or aluminium subframe

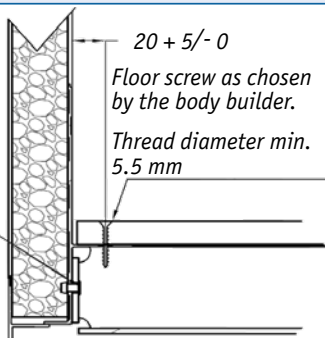

20 + 5/- 0

Floor screw as chosen by the body builder.

Thread diameter min. 5.5 mm

- If using multi-leaf side doors, stiffen the subframe in the under the the side doors and approx. 1 m to the right and left of them if necessary. If necessary, the stiffening must be extended over the full length of the body. The body builder is responsible for this work.
- In case of bodies with coupé doors, you must stiffen the subframe at the coupé doors as well as approx. 1 m to the right of them, especially in the area of the step; e.g. by reinforcing with gusset plates. The body builder is responsible for this.
- When installing floorboards/panels, always take into consideration their swelling behaviour. Ask your board/panel supplier. The joint between the floor and the body is sealed. The body builder is responsible for this.

4. Finishing work



- In case of kits with "Latt um Latt" (batten by batten) feature, after the floorboards/panels have been laid, screw back on the bottom 2 or 3 rows of battens. The body builder is responsible for this work.

- If necessary, screw the inside right handle onto the frame pillar
- Use the plugs supplied to close off the side screw holes in the rear pillars.

- Shorten the inside bracket MA100068/-69 at the markings, depending on the wall thickness. Arrange these as shown in the following figures and fix them with the screws MD100057. Undo any screws already installed at the rear first.

- You can generally paint over our coil coating and powder coated parts with normal wet paints. For secure, reliable adhesion, consult the paint supplier, especially regarding the primer. Apply primer to raw and galvanised sections beforehand. Grind the finish-coated parts with the abrasive pad and remove dust and grease to prepare them for painting. The temperature in the paint booth must not exceed 60°C.

- In case of subsequently attached components or changes to Alu-Team components, pay particular attention to corrosion protection. Above all, you must always prevent contact corrosion caused by different materials. Otherwise, the painting, coating and bonding warranty is voided.

- After installing the box body on the subframe, depending on the features included, pull the connection cable for the side lights out of the right frame pillar, the connection cables for the interior lights and the 3rd brake light out of the left frame pillar. Connect the connection cables to the connection cable of the respective body builder.

- Check the roof corners, doors and lighting for leaks, e.g. perform a water test based on EN 283. To this end, direct a water jet from a ½" nozzle (Ø 12.5 mm inside), with a pressure of roughly 1 bar at the external seal welds. The nozzle must be held at a distance of approx. 1.5 m from the body. After the test, there must be no penetrated water in the body.

Attention: You must wait for 6 weeks before cleaning the body with a steam jet cleaner. Please always note the explanations regarding this in "5. Maintenance".



Attention: Paints, solvents and dust are harmful to health. Protect yourself!



The connection of the adapter cable is always fixed in the right frame pillar



- **VW Crafter / MAN TGE MA350083**
- **Renault Master MA350083**
- **MB Sprinter MA350083**
- **Citroen Jumper MA350083**
- **Opel Movano MA350083**
- **Ford Transit MA350130**
- **Iveco Daily MA350129**



Attention: The assembled box body can be handled, however, you must wait 24 hours before it can be loaded!



5. Maintenance, service, spare parts



For the **body maintenance**, check all screws and bolts (including those of roller shutters!) for tight fit at regular intervals, however, at least once a year. At the same time, check the specified torque.

- Locks and lock cylinders are maintenance parts. Lubricate them to keep them in working order if necessary. Frozen locks due to lack of maintenance are not a reason for complaint.
- Do not clean the body with a steam jet cleaner for at least 6 weeks. To prevent paint damage, maintain a minimum nozzle distance of approx. 300 mm. The water temperature must not exceed 60 °C, the maximum working pressure 100 bar, and the pH-value of the cleaners max. 10.

Then rinse immediately with plenty of clean water. Remove flash rust on stainless steel parts (including the frame) using common household stainless-steel cleaners.

- After cleaning, treat all seals with rubbing care product.

If you have any questions regarding the assembly, please contact our **customer service**:

Tel.: +49 (0)521-41 73 11-30, **Email:** m.wismueller@aluteam.de

If you require **spare parts**, please either contact your local sales representative or call us on: **+49 (0)521 - 41 73 11 - 10**.

Please send emails to: info@aluteam.de



6. Disposal of old box bodies and components















- You can remove the metallic outer layers from the foam core and, like the aluminium sections, hand them over to the scrap trade for recycling. The same applies to the steel and / or stainless-steel components of the frames.
- PUR foam core can be incinerated in thermal waste treatment plants without polluting the environment. The energy in the insulation material is converted into primary energy.
- Plywoods are also used in energy recovery systems. Odour nuisance due to the ammonium additives in the binders must be avoided. In general, plywoods, like particleboards, can be burned in wood-fired furnaces with at least 50 kW nominal heat output. They are subject to significantly stricter carbon monoxide limits than solid wood, for example. These values are mostly only achieved by automatically loaded plants.
- For information on disposing of the foam in the area of the floor, contact the trade association for extruded polystyrene foam (In Germany: Fachvereinigung Polystyrol-Extruderschäumstoff (FPX)), Odenwaldring 68, 64380 Rossdorf (www.fpx-daemmstoffe.de).

7. Kit contents



Please understand that we must reserve the right to make changes to the design, features and technology delivered.

Included in the BR13x-3 kit contents:

- Front wall assembly
- Side wall assemblies, right and left, including rear pillars and any mounted doors
- Roof assembly with integrated frame crossmember
- Frame gusset plates KS 320180 
- In case of Kits for LBW: Top tailgate with pneumatic springs and assembly screws MD 100058 and, depending on the gate version, material for fixing the gate at the side 
- Bottom frame crossmember, depending on the features
- Assembly screw M 6 x 21 Tx 30 self-locking, AluTeam Article No.: MD 100224 
- Internal bracket, front MA100068 and rear MA100069.R / MA100069.L including fastening screws MD100057 
- Rear roof corners MA 100060 
- Blind rivet MD150027 for riveting the rear roof corners 
- For version with insulated floor, Spax screws MD 100345 
- Countersunk screw M 10 x 18 galvanised, MD 100329 
- Frame screws M 10 x 60, MD 100328 
- Plugs MA 150001 for bolting holes in the frame pillars 
- Handle PG210013.002 with self-tapping fastening screws MD 100202 
- 1C sealant and adhesive, bond-activating cleaner
- Front roof corner MA100068 and rear roof corner MA100069.R / MA100069.L incl. 6 fastening screws MD 100057 
- Depending on the features, rear side lights (MA 350080-1)
- If applicable, side marking lights with a connection kit
- If applicable, a connection cable for truck chassis as stated in the purchase order (*see circuit diagram*)
- *If a side door is supplied* (as part of the side wall), optional drip moulding above the door, including mounting material
- **Optional:** Subframe incl. material for installing complete aluminium or steel subframes, see "*Installation instructions for aluminium sub-frame*" (is supplied with the subframe)
- Paper towels
- Sticker with body number
- Assembly instructions

Attention: The sticker is only valid with a certificate issued by AluTeam!