

Assembly Instructions BR 25x-2

Box Body Kits



MA25x2.ENG

Always read through these instructions, completely and carefully, before you start the assembly work.



Table of Contents

1. Safety Instructions and Warnings	2
1.1 Checking the kit contents	2
1.2 Warnings	2
1.3 Safety instructions	3
1.4 Copyright	4
2. Preparatory work / Personnel requirements	4
2.1 Personnel requirements	4
2.2 Tools and equipment required	4
2.3 Tightening torques for screws and bolts	4
2.4 Bonding with AluColl	5
2.5 Preparations	5
3. Assembling the Kit	6
3.1 Installing the floor and front wall	6
3.2 Attaching the side walls	7
3.3 Attaching the roof	7
3.4 Wiring the kit and fastening the roof	8
3.5 Fixing the walls, installing the frame, doors, etc.	9
3.6 Sealing	9
3.7 Body on the underbody or chassis	10
4. Finishing Work	10
5. Maintenance, Service	11
5.1 Maintenance	11
5.2 Service	11
6. Disposal of Old Box Bodies and Components	11
7. Kit Contents	12

1. Safety Instructions and Warnings



These instructions explain how to assemble kits 250-2 to 257-2. To create a fault-free body **always follow the instructions described here**, in particular, the following warnings, **otherwise the warranty is voided**.

If you have received a custom design, it is possible that individual work steps are not explained here. Please also note that coloured representations are for illustration purposes only. **Get in touch with us immediately in case of uncertainties.**

1.1 Checking the kit contents

Check the delivery against the enclosed packing list for completeness. Notify the delivering carrier immediately of any transport damage. Please understand that we must reserve the right to make changes to the design, features and technology delivered. The general kit contents are listed on page 12.

1.2 Warnings

AluTeam generally does not know the precise intended purpose of the kit. **As the body builder, you must match the purchase order and processing of the kit to the requirements of your customer and the body guidelines of the vehicle manufacturers.** This also applies to materials used and surface finishes. Damage due to transport goods such as aggressive chemicals are not a reason for complaint.

- Store the **kit in a dry and clean place** (not outdoors).

- To ensure water cannot penetrate the assembled box body, the **sealing cords** in the profiles must not show any signs of damage.
- Connect the components directly using the screws supplied. The assembly contact surfaces must be free from dirt.
- Use the original screws and bolts, and use them only once (even for repairs). Third party / used screws and bolts endanger operational safety. Screws must not tilt. Never position the screws or bolts at an angle and keep to the specified **torques** (2.3). A torque lower than specified weakens the strength and tightness of the body, a significant exceedance can cause damage to components!
- The body is not designed for docking operations! Set out the underbody so that forces acting through rear bumper guards are transferred **into the auxiliary frames or the chassis**.
- The fastenings between the longitudinal chassis beams and chassis frame must be made as described in the **body guidelines of the respective chassis manufacturer**. The two front fastenings at least must be spring-mounted. Otherwise, forces that occur, e.g. in case of cornering, load changes or non-uniform loading, are transferred onto the body and can cause cracks in the body structure.

1.3 Safety instructions

Pay attention to your own safety and to that of your employees. Working with kits involves hazards. Therefore, caution is always necessary, in particular, you should definitely:

- ... **Wear safety gloves.** Wear **safety footwear**, as heavy parts can fall. Wear **hearing protection** as well as **safety goggles** when working with air screwdrivers, grills, grinding equipment, etc. Wear a **helmet** when working with or near a crane.
- ... when unloading / transporting the kit in the transport rack using a crane, use a suitable lifting beam. If using a forklift truck, push the transport rack completely onto the fork arms.
- ... Place transport racks on level surfaces only and secure them against tilting and toppling, secure any assembly dollies against rolling away.
- ... Always lift assemblies vertically, not at an angle! Never step under raised loads! The suspension point/anchorage in the crane must always be above the assembly's centre of gravity!
- ... remove all packing straps in the specified order during assembly, always remove the white packing straps first. The individual components and assemblies are held by a red packing strap. Secure the part to be removed against toppling before cutting the packing strap.
- ... if you lift the floor using the airline rails, use at least 2 double-stud fittings with sufficient load-bearing capacity.
- ... lift the roof with a lifting beam or vacuum lifter only! The roof mounting strips (airline rails) are used as an assembly aid only. They must not be used to lift assembled box bodies. **Risk of pulling out!**
- ... comply with all relevant legal requirements in your country, such as laws, regulations, etc. regarding road traffic and goods transport, as well as all relevant occupational health and safety regulations. This is the responsibility of the body builder.
- ... when cleaning and sealing, ensure adequate ventilation and following the use, safety and disposal instructions of the adhesive / sealant manufacturers. Request the safety sheet and the instructions for use from the manufacturer as printed on the cartridge or contact **+49 (0)521 4173 -1110**.



suspended loads on the crane



falling objects



toppling parts or assemblies



Risk due to high-pressure cleaners



hazardous materials



Risk of scalding

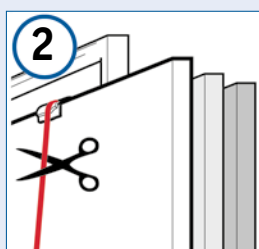
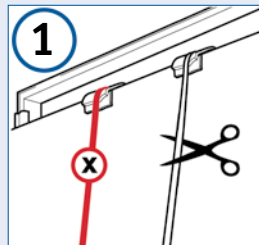

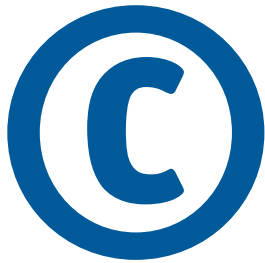

1.4 Copyright

AluTeam holds the copyright to these instructions. They are intended for the assembly company and its personnel and may not, neither as a whole nor in part, be:

- reproduced
- distributed or
- otherwise disclosed.

Infringements can result in civil and criminal charges!

2. Preparatory work / personnel requirements

AluTeam kits can be assembled in any well-equipped workshop. Carry out the following preparations beforehand.

2.1 Personnel requirements

1-2 fitters with training as a vehicle or vehicle body builder or equivalent training are required.

2.2 Tools and equipment required

Before starting the assembly, make sure the following equipment is to hand:

- Measuring tape
- Precision air or cordless screwdriver with torque setting up to 12 Nm (e.g.B. Fein Accutec or comparable)
- Power screwdriver bit Tx 30 (DIN 3126 / ISO 1173), extra hard type, ¼" drive, min. 70 mm length (AluTeam Article No. MH170107)
An extension for screwdriver pits may be useful
- Torque wrench up to 200 Nm
- Carrying straps with 4 double-stud fittings (e.g. LoadLok 5018 or allsafe JUNGFALK 7105/75018)
- Ratchet and socket for floor screw M14, hexagon socket for hexagon head cap screw M10
- Assembly dolly or Euro pallets or suitable support trestles
- Double barrel dispenser gun for AluColl7720 (e.g. pneumatic gun for tandem cartridge, mix ratio 4:1, adhetek PPA300B/3 BI-Mixer)
- Pneumatic or manual dispenser gun for 310 ml sealant cartridges
- Rivet gun for rivet diameter 5 mm
- Crane with at least 1 tonne working load limit and vacuum lifting beam or lifting gear
- Hammer (500 g), Punch d = 3 mm and d = 4 mm
- 2 standing ladders or scaffold unit
- HSS drill bit Ø 5.0 mm (shorter than the wall thickness!)
- If necessary, Spax screws 5 x 40 mm for flooring with plywood surface
- Painter's putty knife

2.3 Tightening torques for screws and bolts

You only join the components together directly. After setting it, the named power screwdriver type has a uniform, tight tightening torque. The torques apply to a dry thread. The settings for the screws and bolts must be checked using appropriate measuring equipment. **Set the following torque:**

- | | |
|--------------------------------------|--------------|
| ○ Assembly screw M 6 x 21 (MD100224) | 10 Nm ± 1 Nm |
| ○ Pan head screw M 6 x 26 (MD100318) | 5 Nm ± 1 Nm |
| ○ Frame screw M 10 x 30 (MD100227) | 60 Nm ± 5 Nm |
| ○ Hinge screw M8 x 14 (MD100366) | 25 Nm ± 1 Nm |





Attention: If you use **adhesives or sealants other** than those supplied by AluTeam, you are responsible for the seals and bonding carried out with these alternative products. There is **no guarantee cover for this.**



2.4 Bonding with AluColl

- The ambient temperature for components as well as adhesives and sealants must be at least 15°C; for AluColl, the ideal temperatures are 20°C, max. 30°C. Adjust the temperature of the adhesive if necessary. Before bonding, clean with Sika Remover 208 and after approx. 10 sec. flash-off time, treat with Sika Coating Activator. You can bond after approx. 15 min. flash-off time.
- Position the cartridge with the threaded end pointing vertically upwards. Undo the black union nut and remove both plugs. Push the static mixer 08-24, with the large opening, firmly onto the cartridge and check for correct fit. Place the union nut on the mixer and tighten it. Place the cartridge in the double barrel dispenser gun.
- Press some adhesive out of the static mixer. Discard the first 20 – 30 cm of adhesive, it does not yet have an optimum mix ratio. Shorten the mixer for the required application quantity, the last section of the static mixer must be retained, otherwise it will be irreparably damaged. One mixer is sufficient for a complete kit.
- Apply adhesive on the dry, grease and dust-free components. After max. 20 min., press more adhesive through to avoid hardening in the mixer. In case of work interruptions lasting longer than 30 min. it must be replaced, as hardened adhesive irreparably damages the cartridge.
- The maximum operating pressure of the air gun is 10 bar.
- If the quantity of adhesive discharged is too small, please check the following:

Error / cause	Action
Static mixer opening too small	Increase the size of the discharge opening
Adhesive is too cold	Carefully heat the adhesive slightly (e.g. in water bath)
Built-in pressure controller is closed	Open the pressure controller
Operating pressure is too low	Increase the operating pressure
Operating pressure is too low	Use compressed air hose with larger cross-section
Quantities of hardened adhesive have already formed in the static mixer	Change the static mixer
Adhesive stuck on the push rods	Remove adhesive residues

AluTeam-kits can be assembled in any well-equipped workshop! Carry out the following preparations beforehand:



2.5 Preparations

- Check the delivery (1.1) and that the bottom rail of the walls as well as the floor section are damaged. Damage can make the assembly difficult or even impossible!
- Secure the overall kit against toppling, as well as the individual assemblies. Provide **sufficient free space** (at least 3 m) on both sides, as well as in front of and behind the vehicle and the required **Tools and Equipment** (2.2).
- For ergonomic working, the kit should be in a somewhat raised and level surface. In case of off-vehicle preassembly, place the floor of the kit e.g. on assembly dollies, pallets, trestles or polyurethane foam blocks. The floor must not sag, to ensure that the walls have full contact with the floor along their whole length.
- The corner pillars may not be closed off from below, as you may have to lay cables here later. The bottom rail section should be supported by at least 100 mm. It is advisable to place supports under the middle area, the fixing holes must remain clear.

3. Assembling the kit



Fig. 3.1.1

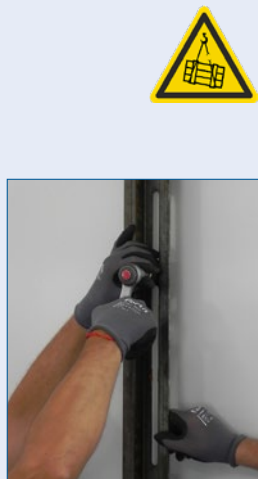

Fig. 3.1.2



Fig. 3.1.3

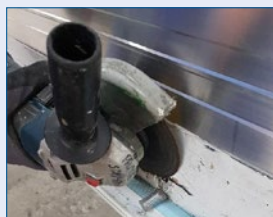

Fig. 3.1.4

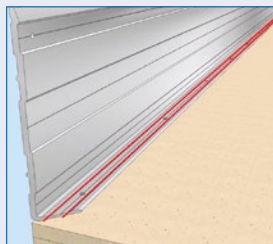

Fig. 3.1.5



Fig. 3.1.6

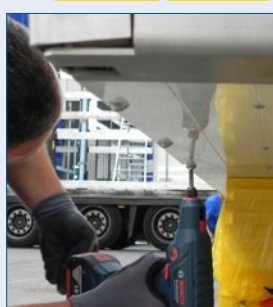

Fig. 3.1.7

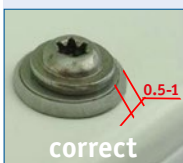

Fig. 3.1.8



Fig. 3.1.9



Fig. 3.1.10



Fig. 3.1.11

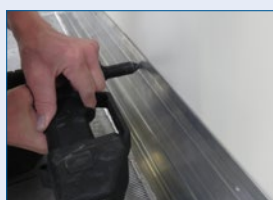

Fig. 3.1.12

3.1 Installing the floor and front wall

The floor is usually delivered to you fixed vertically on transport racks. A sticker on the underside of the floor explains how to handle the floor.

- Hang the horizontal floor in the crane by the two eyebolts provided and unload the transport rack so that you can unscrew and remove it (Fig. 3.1.1 & 3.1.2).

Danger: Crane work involves hazards to life and limb. Never step under raised loads! Always wear a helmet when working near or on the crane. Lift loads vertically only and never at an inclined angle! The suspension point/anchorage in the crane must always be positioned above the assembly's centre of gravity!

- Tilt the module into a horizontal position on suitable supports (Fig. 3.1.3.). Ensure that the bottom rails are positioned on a stable support, e.g. assembly dollies or pallets. Detached topcoats caused by unsupported sections are not a reason for complaint.

- Remove the eyebolts and cut through the two threaded bolts with the help of an angle grinder (Fig. 3.1.4). Then seal the open cut with sealing compound.

- In case of floors with a plywood surface and baseboard rails supplied unattached, grind, clean and bond these onto the floor with 2C adhesive and screw them with, e.g. Spax screws 5 x 40 (not supplied) at a spacing of approx. 300 mm (Fig. 3.1.5). This can also be done after the wall has been attached.

- Use a crane and lifting gear or a vacuum lifting beam to remove the front wall from the transport unit. Lower the front wall carefully onto plywood or foam boards.

Danger: Toppling assemblies are a risk to life and limb. The front wall e.g. remains secured in the crane so that the it does not topple.

- Clean the side of the front wall facing the baseboard rail (SSL). Allow it to flash-off. Grind the back of the baseboard rail, which you also clean and flash-off.

- Position the 6 adhesive beads with a diameter of at least 8 mm carefully on the raised areas of the section contour (Fig. 3.1.6).

- Position the front wall above the bottom rail section installed under the floor and align it. **Secure the wall against toppling.** Set the tightening torque of the screwdriver to 5 Nm \pm 1 Nm. Fix the wall onto the floor from the bottom with screws MD100318 and ring seals MD110044 (Fig. 3.1.7).

Attention: To maintain the sealing function, the sealing washer must not be pressed out from under the screw head by more than approx. 0.5 - 1 mm (Fig. 3.1.8 - Fig. 3.1.10)!

- Drill through the predefined holes in the baseboard rail into the surface layer of the panel and rivet through these holes to fix the front wall onto the baseboard rail (rivets MD150023). The drill bit must be significantly shorter than the wall thickness (Fig. 3.1.11 & Fig. 3.1.12). Remove any adhesive that emerges immediately with, e.g. Sika Remover 208.

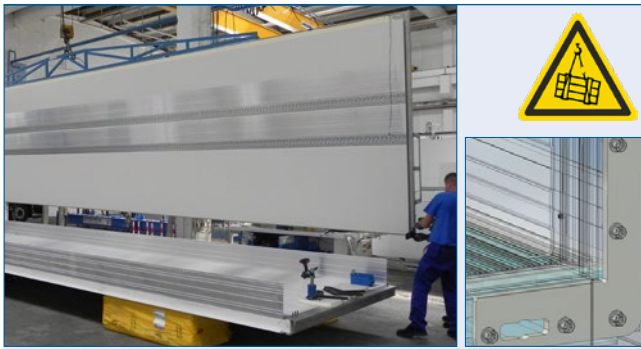

3.2 Attaching the side walls

- Use suitable lifting gear (crane with suitable lifting gear, vacuum lifting beam, sheet metal lifter) to lift the 1st side wall at its centre of gravity. Lower the wall onto plywood or foam boards and leave it secured in the crane. **Follow the safety instructions!**
- Ensure that there are no cables between connection points (**Risk of crushing the cables**).
- If the frame is bolted, guide the gusset plate into the bottom frame crossmember preassembled in the floor and fasten it finger-tight with 2 screws MD100227 as well as the stainless steel plain washers 10.5 mm supplied.
- Grind the back of the baseboard rail. Clean it and the corresponding area of the side wall. Leave both areas to flash-off for at least 15 minutes.
- Apply the adhesive uniformly on the raised areas of the section contour, as for the front wall attachment.
- Position the side wall at the front wall and lower it onto the bottom rail section installed under the floor. Now align the wall.
- Now screw the frame pillar onto the gusset plate, finger-tight, with three screws MD100227 and plain washers 10.5 mm.
- Now screw the side wall onto the floor from below, initially with 3-4 screws MD100318 each together with the ring seal MD110044. Again, pay attention to deformation of the sealing washer. If necessary, use the punch as an assembly aid.
- Drill through the holes in the baseboard rail, in the same way as for the front wall, into the surface layer of the panel. Rivet the side wall onto the baseboard rail using rivets MD150023.
- One employee secures the external components. The 2nd employee screws in 3 screws MD100224 (torque 10 Nm ± 1) on the inside, starting from the bottom up to approx. $\frac{3}{4}$ of the box height, until the sections are pressed together. A screw must also be inserted under the floor!
- Then install the second side wall in the same way as the first.
- Check, and correct if necessary, the angularity and diagonal dimensions of the parts installed until now.

3.3 Positioning and fastening the roof

- Use the crane and lifting gear or vacuum lifting beam to remove the roof from the transport unit. Place the roof in a horizontal position and hook the single-stud fittings into the roof assembly rails (if you are working without a vacuum lifting beam). The fittings must be tight! Depending on the kit length, 2 or 4 fittings are required.
- Push the top frame gusset plates, with the pointed tip facing downwards, sideways into the frame crossmember (**A & B**). If necessary, insert the side lights into the crossmember.
- Screw the gusset plates with 2 screws MD100227 and plain washers 10.5 mm each by hand so that they are slightly tightened.



- If a kit includes a top tailgate, fasten it onto the roof flange, using the holes provided in the hinge and assembly screws (included in the material for the top gate).
- Lift the roof with the single-stud fittings or the vacuum lifting beam. Centre the roof, starting from the front, on the top rail of the front wall (bulkhead). The roof caps grip over the corner pillars. Align the roof with the wall sections.

Danger: Crane work involves hazards. Never step under raised loads! Wear a helmet. **Lift the horizontal roof at the assembly's centre of gravity, never lift it with an inclined angle!**



Fig. 3.4.5

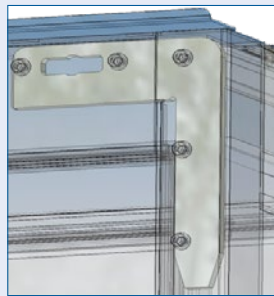

Fig. 3.4.1

3.4 Wiring the kit and fastening the roof

- Lower the roof slowly. If necessary, use a painter's putty knife as an assembly aid. Centre the downwards pointing frame gusset plates in the pillars (Fig. 3.4.1). Fix them on each side with three vertically positioned hexagon head cap screws MD100227 and plain washer 10.5 mm - finger-tight!

Attention: The screws must not tilt, the cables and connectors must not be crushed!

- The cable connections of the BR 25x-2 kits can be installed very easily as follows:

To **wire the side lights** (Fig. 3.4.2) only fit together the connectors (1 / 3 / 4) and then push the plug-in connection (5) into the right-hand frame pillar.

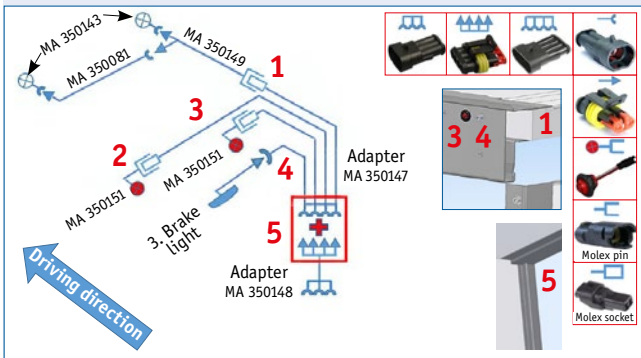

Fig. 3.4.2

- Now continue to connect the various lights:

To **wire the LED strips with motion detectors (infrared sensor)** fit together the connectors (7 / 8) and push the plug-in connection (6) into the left-hand frame pillar (Fig. 3.4.3).

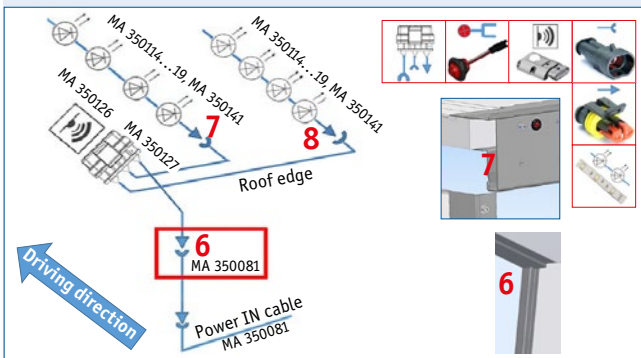

Fig. 3.4.3

To **wire the LED strips without motion detectors** fit together the connectors (7) and push only the plug-in connection (6) into the left-hand frame pillar (Fig. 3.4.4).

Note: The figure shows wiring with LED strips on the right / or on the left-hand side.

- Screw the roof from above with 3 - 4 screws MD100318, together with ring seals MD110044 uniformly distributed on each side, working from the front back (Fig. 3.4.5 - top lh.). Set the screwdriver tightening torque to 5 Nm ± 1 Nm. Watch out for deformation of the sealing washer, as for the front wall installation!

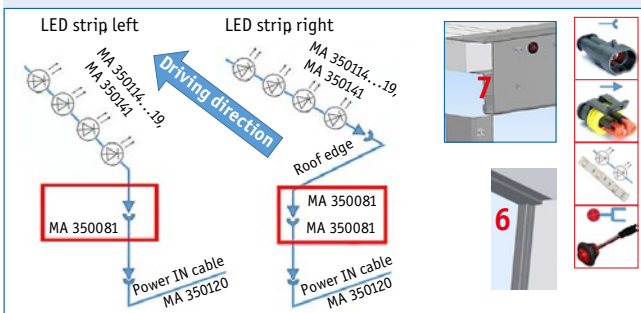

Fig. 3.4.4



Fig. 3.5.1



Fig. 3.5.2



Fig. 3.5.3

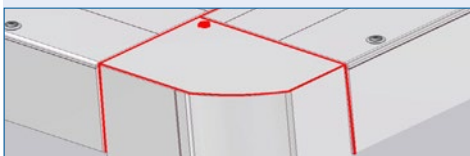

Fig. 3.6.1

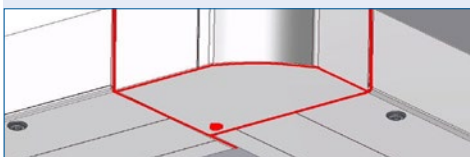

Fig. 3.6.2



Fig. 3.6.3

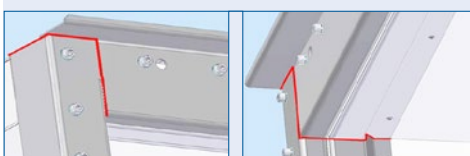

Fig. 3.6.4

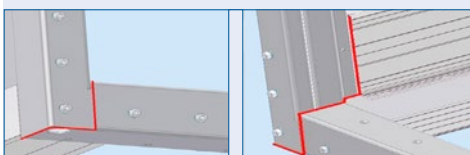

Fig. 3.6.5

3.5 Fixing the walls, assembling the frame, doors, etc.

- If the kits have a top gate, latch the gas springs of the gate onto the ball heads.
- Measure the diagonals of the frame and correct them if necessary, until they match.
- Screw in the remaining screws MD100224 to the required torque from the inside, into the side wall / front wall connections, until the sections are pressed together.
- Fill the cavity between the front wall and side wall with the piece of cut foam supplied and close off the inside body corners with the corner covers using rivets MD150023 (Fig. 3.5.1).
- Screw the floor, roof and side walls with the remaining screws MD100318 and the ring seal MD110044. As for the front wall installation, watch out for deformation of the sealing washers!
- Tighten the screws of the top frame gusset plates and the screws of the frame crossmember to the correct torque. The rear surface of the crossmember must form a flush plane with the rear surface of the pillars. Remove the single-stud fittings from the roof assembly rails.
- Now seal the component crossovers of the frame.
- If a kit includes doors, remove them from the transport rack and position them with the help of the crane. Screw the door hinges onto the hinge bracket of the rear frame. If necessary, adjust the rotary bar locks by adjusting the position of the hitches (Fig. 3.5.2). Check the screws and bolts for tight fit.
- Bond and rivet the sheet metal covers in the front corners under the floor.
- Mount the PA rail with rivets MD150024 (Fig. 3.5.3).

3.6 Sealing

- Use the bond-activating cleaner of the kit to clean the sealing surfaces and after approx. 10 sec. flash-off time, treat them with Sika Activator 205.
- **After approx. 10 min. flash-off, seal with the sealing compound:**
 - Front right and left roof corner, all round from above, and the rivet head (Fig. 3.6.1).
 - All round the sheet metal cover under the floor as well as the rivet head. (Fig. 3.6.2).
 - The connection of the walls on the roof and the inside corner cover. (Fig. 3.6.3).
 - The connections of the top frame crossmember to the pillars. (Fig. 3.6.4).
 - The connections of the bottom crossmember to the pillars (Fig. 3.6.5).
- Close off the wiring of the pillars with sealing compound.
- **The seals should only be pressed in and smoothed with smoothing agent or water – without soap additives.**
- If necessary, the joint between the side door and the floor must also be sealed.



Fig. 3.7.1

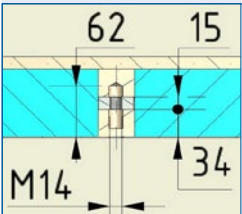

Fig. 3.7.2

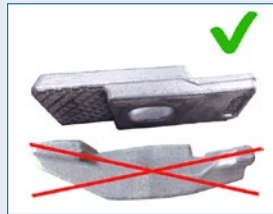

Fig. 3.7.3

3.7 Body on the underbody or chassis

- Place the underbody or the chassis – aligned horizontally and torsion-free – onto a level surface.
- Use the crane and lifting gear to position the finished box body on the auxiliary frame or the chassis (Fig. 3.7.1). Never lift the assembled box body by the roof eyebolts. **Risk of pulling out!**
- Fasten the body using the threaded inserts in the floor and the (not supplied) M14 - screws and washers, tightening torque 120 Nm. The screw length depends on the depth of the threaded hole (Fig. 3.7.2) and the possibly used **clamping claw** for clamping the floor on the longitudinal chassis beam.

It **must have a level contact surface with the underside of the floor** (Fig. 3.7.3). Clamping claws that are not positioned with their full surface, e.g. with two-point support, damage the floor! The body builder is responsible for the body fastening.

4. Finishing Work

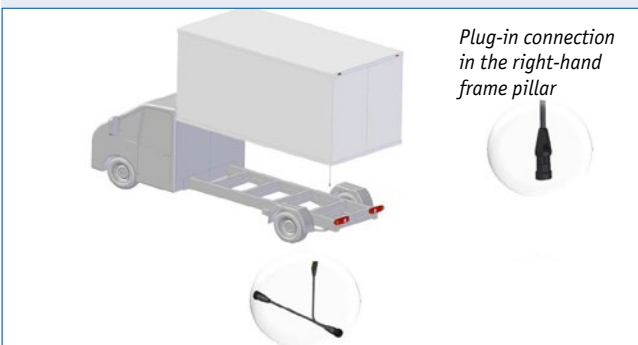

Plug-in connection
in the right-hand
frame pillar

Supplied connection cable

Mercedes: Atego, Antos, Actros - MA350155 & MA350083
 MAN TGM, TGL, TGE, as well as VW Crafter and Scania: MA350158
 DAF: MA350157 & MA350156
 Iveco Eurocargo: MA350190 / Iveco Daily: MA350159
 MB Sprinter, Opel Movano Citroen Jumper Peugeot Boxer: MA350158
 Mitsubishi Fuso Canter, Fiat Ducato, Renault Master: MA350158
 Ford Transit: MA350168

Fig. 4.1



Attention: Paints, solvents and dust are harmful to health. Protect yourself!

Fig. 4.2



Fig. 4.3

- After assembling the box body on the underbody, depending on the features supplied, pull the connection cable for the side lights out of the frame pillar and connect it to the connection cable of the respective vehicle manufacturer (Fig. 4.1).

- Unless ordered otherwise, the kit is finish coated. If necessary, paint coil-coating and powder-coated parts with conventional wet paints (Fig. 4.2). For secure, reliable adhesion, consult the paint supplier, especially regarding the primer.

Untreated and galvanised sections must be treated with a suitable primer before painting. Grind the finish-coated parts supplied with the abrasive pad and remove dust and grease to prepare them for painting. The temperature in the paint booth must not exceed 60°C.

- In case of subsequently mounted parts or changes to AluTeam components, pay attention to corrosion protection and **above all, prevent contact corrosion caused by different materials!** Otherwise the guarantee and warranty for the painting and coating will be voided.

- After the box body assembly, you now only check the roof corners, doors and the lighting for leaks.

- The assembled box body can be moved but not loaded. The final strength of the sealant is reached after 24 hours at 20° C. The operating temperature must be at least 15° C.

Attention: You must wait for 6 weeks before cleaning the body with a steam jet cleaner. Please always note the explanations regarding this in "6. Maintenance, Service".

- Body strength stickers are only valid in conjunction with a body strength certificate of an independent test organisation issued through AluTeam.

- To perform a water test on bodies, based on EN 283, use a water jet from a ½" nozzle (Ø 12.5 mm inside) to test the external seal welds, at a pressure of roughly 1 bar. The nozzle must be held at a distance of at least 1.5 m from the body to be tested. After testing, there must be no penetrated water in the body (Fig. 4.3).

5. Maintenance, Service



5.1 Maintenance

Visually inspect body screws with sealing washer regularly. If necessary, replace seals (e.g. which swell out) and screws. At the same time, check the specified torque.

- Locks and lock cylinders are maintenance parts. Lubricate them to keep them in working order if necessary. Frozen locks due to lack of maintenance are not a reason for complaint.
- When cleaning the body with a steam jet cleaner (after 6 weeks at the earliest) maintain a minimum nozzle distance of 300 mm. The maximum allowable water temperature of the cleaner is 60°C, the maximum working pressure is 100 bar, and the pH-value is 4 - 10. Rinse immediately with clean water. Remove flash rust on stainless steel (including the frame) using common household stainless steel cleaners.
- Check all seals regularly and always treat with a rubber care product after cleaning.

5.2 Service

If you have any questions regarding the assembly, please contact our **customer service**:

Tel.: +49 (0)521-41 73 11-30, Email: m.wismueller@aluteam.de

If you require **spare parts**, please either contact your local sales representative or call us on: **+49 (0)521 - 41 73 11 - 10.**

Please send emails to: info@aluteam.de

6. Disposal of Old Box Bodies and Components









- You **can remove the metallic outer layers** from the foam core and, like the aluminium sections, hand them over to the scrap trade for recycling. The same applies to the steel and / or stainless steel components of the frames.
- A **PUR foam core** can be incinerated in thermal waste treatment plants without polluting the environment. **Plywood**, like particleboards, can be burned in wood-fired furnaces with at least 50 kW nominal heat output. They are subject to stricter carbon monoxide limits than solid wood. These values are mostly only achieved by automatically loaded plants. Odour nuisance due to the ammonium additives in the binders must be avoided.
- **GRP** must be processed by a recycling/recovery company, and is used as a substitute fuel. For energy recovery in a cement works, the EWC code is 070213 (waste plastic).
- For information on disposing of the **foam in the area of the floor**, contact the trade association for extruded polystyrene foam (in Germany: Fachvereinigung Polystyrol-Extruderschäumstoff (FPX), Odenwaldring 68, 64380 Rossdorf (<https://xps-spezialdaemmstoff.de/wpcontent/uploads/XPS-mit-halogenfreien-Treibmitteln-1.pdf>))
- **Hardened adhesives and sealants** are disposed of as residual waste (black bin). **Residual quantities of solvents**, as hazardous waste, must be handed into the respective disposal company or collection point. The technical data sheets can be requested from the individual manufacturers.

7. Kit Contents



Please understand that we must reserve the right to make changes to the design, features and technology delivered.

A BR 25x-2 kit includes:

- Front wall assembly
- 2 x side wall assemblies (rh/lh) with mounted rear pillars and, depending on features, with attached doors
- Roof assembly with integrated frame crossmember incl. frame gusset plate as well as preassembled roof corners
- Optional rear steel frame, e.g. in kits with roller shutter frame
- In case of liftgate kits: Top tailgate with pneumatic spring and Mounting screws MD100058 
- Assembly screw M6x21 Tx30 self-locking, Article No.: MD100224 
- Pan head screws with flange for connecting the wall elements to the roof from above, M 6 x 26, AluTeam No.: MD100318  as well as suitable ring seals
- 2 x pieces of cut foam for the cavity between the front wall / side wall
- 2 x corner covers for the vertical front body inside corners
- Depending on features, 4 x galvanised frame gusset plates, bolted type, as corner connector for the integrated frame
- VA hexagon head cap screws MD10022M10 x 30  - frame gusset plate connection to the pillars and frame crossmembers, top and bottom
- VA Plain washers 10.5 -140HV Form A for screw MD100227
- Avinox Blind rivet Ø 4.8 x 11.3 VA Article No.: MD150023 
- Wing-type drilling screw with countersunk head MD100300  Ø6x60 – AW30 (for option with roller-shutter frame crossmember)
- 2 x metal cover sheets for facing the front corners under the floor
- Depending on the features, rear side lights (*see circuit diagram*)
- If applicable, side marker lights with a connection kit
- If applicable, a connection cable for the truck chassis, as in the purchase order (*see circuit diagram*)
- If applicable, PA rails incl. Avinox blind rivet Ø 4.8 x 14.3 VA MD150024
- 2-component adhesive AluColl 7720 Tandem cartridge
- Static mixer for tandem cartridge
- Sikaflex-515 white sealant
- Sikaflex-221 grey sealant (for the stainless steel frame)
- Sika Activator 205 pretreatment agent
- Sika Remover 208 cleaner
- Sika Coating Activator
- Paper towels
- Sticker with body number
- *Optional sticker “Tested load security”*
Attention: *The sticker is only valid with a certificate issued by AluTeam*
- Assembly Instructions