

## Assembly instructions

# Roller Shutter for 13x-2/13x-3



MA 010041-EN

*Always read through these instructions, completely and carefully, before you start the assembly work.*



## Table of Contents

<b>1. Preparatory work, Safety Instructions and Warnings</b>	2
1.1 Scope of delivery, tools and equipment required	2
1.2 Safety and Warning instructions for the installation	3
1.3 General safety instructions and warnings	4
<b>2. Installation of the roller shutter</b>	5
2.1 Assembly of lintel and rear frame gusset plates	5
2.2 Installation of guide rails, spring shaft and striker plate	5
2.3 Assembly of the panels	6
2.4 Hang the shutter into the guide rails	7
2.5 Placing on the rope, adjusting the roller wheel brackets	8
2.6 Adjusting the spring force	8
<b>3. Finishing work</b>	10
<b>4. Maintenance, service, spare parts</b>	11
<b>5. Disposal of worn-out parts</b>	11
<b>6. Copyright</b>	11
<b>7. Installation drawing DP25 HR</b>	12

## 1. Preparatory work, Safety Instructions and Warnings

This instruction explains the installation of roller shutters in the 13x-2 and 13x-3 series. **1-2 fitters with training as a car-body and vehicle builder** or equivalent training are required for this.

**Follow this instruction exactly** in order to ensure the trouble-free function and a long service life of the roller shutters. An installation in accordance with the installation instructions represents the basis for the guarantee in accordance with valid EU law, **otherwise the warranty is voided**. Contact us immediately in the event of any uncertainties.

- Unload the kit with all due care. Avoid damages e.g. from impact or the toppling over of components. Observe the safety and warning instructions under 1.2.



### 1.1 Scope of delivery, tools and equipment required

Please check the delivery for completeness using the enclosed packing list. Immediately report any transport damages to the forwarder. Please understand that we reserve the right to make changes to the scope of delivery in Form, equipment and Technology. **The scope of delivery generally includes:**

- 1 pair of horizontal and 1 pair of vertical guide rails
- 1 spring shaft
- 1 set aluminum panels (number is indicated on the packing list)
- 1 pair of side seals
- 1 carton with small parts
- these installation instructions, as well as an installation drawing
- 1 stick-on label of notes on safety and inspection instructions

**The aluminum panels supplied are quality powder-coated on the outer side.** Only in case of special customer preference are the panels bright-rolled. Their preparatory treatment requires special care and experience. A guarantee for the paint adhesion is dispensed with in this case. You can also repaint powder-coated rolling gates later through roughening, priming and cover-painting.



AluTeam kits can be assembled in any well-equipped workshop! Before starting the assembly, make sure the following equipment and tools are available:

- Tape measure
- Precision compressed air or battery powered screwdriver or drilling machine
- 2 vise-grip wrenches
- Rivet device and welding device for diameter  $d = 5 \text{ mm}$  &  $d = 6,5 \text{ mm}$
- Hammer
- Drill bit  $d = 5 \text{ mm}$  /  $d = 6,5 \text{ mm}$  /  $d = 8 \text{ mm}$
- Steel rods approx. 450 mm long  $\varnothing 13 \text{ mm}$
- Bolt spanner SW 11, SW 13, SW 14 (15)
- Hexagonal socket wrench SW 4
- Stepladders
- Screw clamps
- Hand lamp
- 2 wood pieces approx. 50 x 50 x 100 mm
- Safety shoes and safety gloves



## 1.2 Safety and Warning instructions for the installation

AluTeam normally does not precisely know how the kit and the roller shutter is going to be used. As the vehicle builder, you must adjust the order and further processing of the kit to the needs of your customers as well as to the installation guidelines of the chassis manufacturer.

- Never position screws or bolts at an angle. The screws must not tilt. Connect components only in direct contact with the supplied screws and only once! Third-party or used screws endanger operational safety. Always use new screws for repairs.

**Please pay attention to your own safety and that of your employees.** Working with kits bears risks. Therefore, be cautious at all times, and it is especially imperative that:

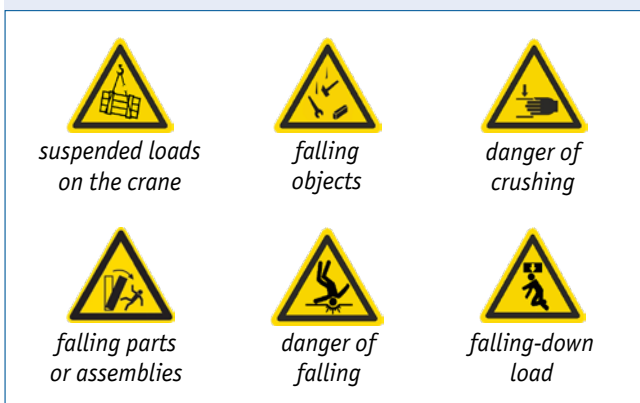

... when **unloading** with a forklift, slide the pallet onto the forklift prongs completely. Place down construction sets on flat surfaces only and secure them against tilting, tipping over and falling down.

... always **wear a helmet during crane work** and only lift assemblies vertically and not at an angle! Never walk under high loads! The suspension in the crane must always be above the centre of gravity of the assembly!

... **comply with legal specifications**, such as vehicle licensing regulations. This is the responsibility of the vehicle manufacturer.

... note that component parts can have zinc protrusions and sharp edges. Therefore always **wear safety gloves**. Likewise you should **wear safety shoes** since heavy parts can fall down.

# ACCIDENT HAZARD!



## 1.3 General safety instructions and warnings

**Attention:** The roller shutter is approx. 70 - 100 kg in weight. Strong springs keep it in balance. Damage can lead to malfunctions and accidents. Therefore, **please observe these instructions and be sure to pass them on to your customers:**

- **Check** all parts for secure fastening **before use**. Loose fixing is to be retightened or replaced. Check the webbing, the tension ropes, belts, rollers and hinges. Replace them immediately if they are damaged!
- **During use check** the interlocking and the opening function. If these are stiff, oil the interlocking of rollers, bearings, hinges, rails and spring shaft with light creeping-oil. Bearing which are not oiled seize up with rust.
- Only qualified persons may implement **further repairs**. Without precise knowledge do not attempt to adjust the spring shaft which is under stress or replace damaged ropes yourself.
- **Never block off the rails and gate area**. When the shutter is in motion, the gate area must be free of obstacles. Do not activate defective and blocked gates!
- **Toppling over of the loading area** can cause life-threatening accidents! Caution; the gate belt can tear! Therefore never use the belt for ascent or descent.
- Before starting the drive, **the gate must be closed and locked**. Driving with open gate damages it.
- **Lost or damaged notes on safety** are to be replaced. Never paint over notes on safety!
- **High-pressure cleaners or aggressive solvents** can damage the paint coat and the seals.
- **Use only original AluTeam spare parts**.
- In case of subsequently mounted attachments or changes to AluTeam components, **pay particular attention to corrosion protection**. Above all, you must always prevent contact corrosion caused by different materials.

### WARNING!

### General safety instructions and warnings



Toppling over of the loading area can cause life-threatening accidents!

Caution! The gate belt can tear!

Never use the belt for ascent or descent.



When the shutter is in motion, the gate area must be free of obstacles.

ACCIDENT HAZARD!

The roller shutter is approx. 70 - 100 kg in weight. Strong springs keep it in balance. Damage can lead to malfunctions and accidents. Therefore, please observe these instructions and be sure to pass them on to your customers:

#### Before use

1. Check all parts for secure fastening before use. Loose fixing is to be retightened or replaced.
2. Check the webbing, the tension ropes, belts, rollers and hinges. Replace them immediately if they are damaged!

#### During use

1. Check the interlocking and the opening function. If these are stiff, oil the interlocking of rollers, bearings, hinges, rails and spring shaft with light creeping-oil. Bearing which are not oiled seize up with rust.
2. Replace damaged rollers, bearings and hinges.
3. Only qualified persons may implement further repairs. Without precise knowledge do not attempt to adjust the spring shaft which is under stress or replace damaged ropes yourself. ACCIDENT HAZARD!
4. Never block off the rails and gate area. When the shutter is in motion, the gate area must be free of obstacles. Do not activate defective and blocked gates!
5. Toppling over of the loading area can cause life-threatening accidents! Caution; the gate belt can tear! Therefore never use the belt for ascent or descent. ACCIDENT HAZARD!

#### Before starting the drive

The gate must be closed and locked. Driving with open gate damages it.

#### Maintenance, service, spare parts

1. Lost or damaged safety instructions must be replaced. Never paint over safety instructions!
2. High-pressure cleaners or aggressive solvents can damage the paint coat and the seals.
3. Use only **original SCHNEIDER spare parts**.
4. In case of subsequently mounted attachments or changes to Schneider components, pay particular attention to corrosion protection. Above all, you must always prevent contact corrosion caused by different materials.

AluTeam Fahrzeugtechnik GmbH, Brockhagener Str. 88, D-33649 Bielefeld, Phone +49 (0)521 - 41 73 11 - 0



## 2. Installation of the roller shutter

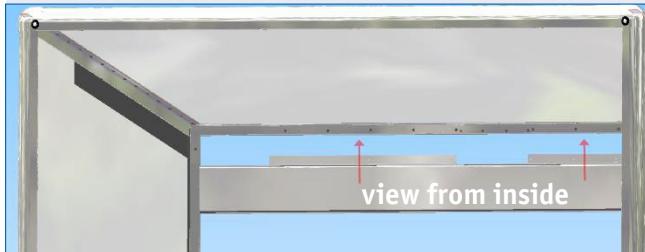

Fig. 2.1.1

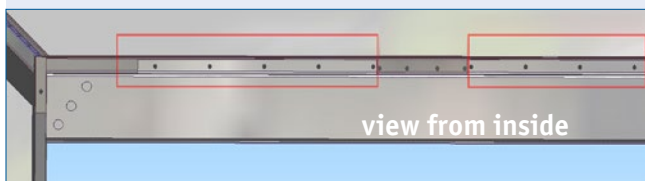

Fig. 2.1.2

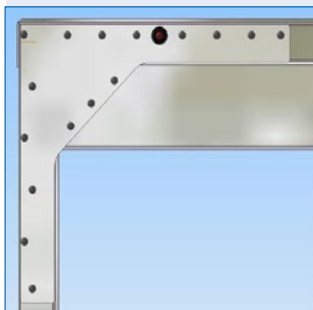

Fig. 2.1.3

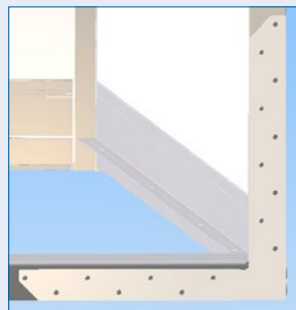

Fig. 2.1.4

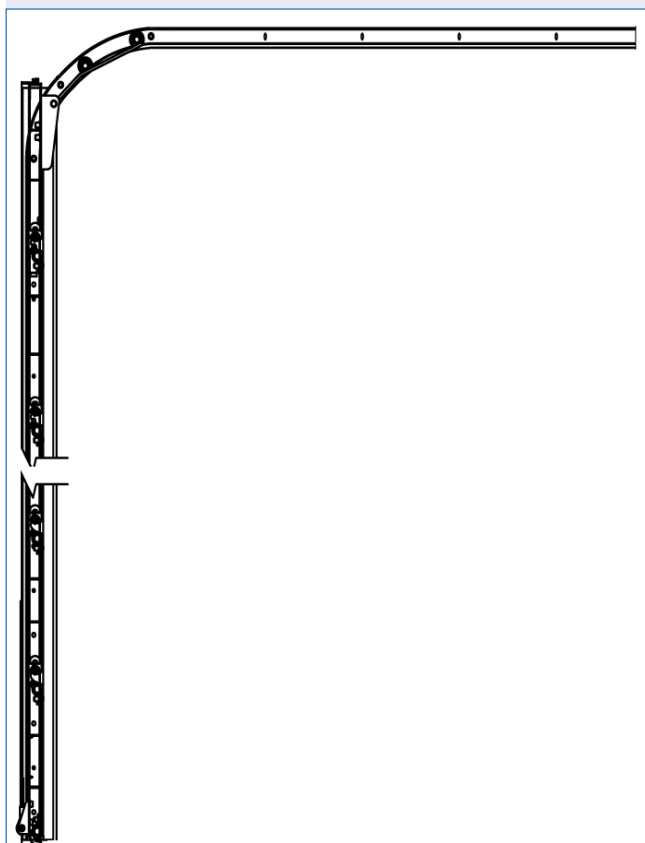

Fig. 2.2.1

### 2.1 Assembly of lintel and rear frame gusset plates

- Align the rear frame in the diagonal. In the next step insert the lintel from the bottom to the top (Fig. 2.1.1).
- Now rivet the lintel to the upper roof end through the existing holes (Fig. 2.1.2). Take the rivets MD150041 for this purpose.

**Tip:** The inner edges of the corner pillars and the shutter lintel must be on one level. To prevent water from entering through the door and flowing onto the loading area, we supply a door sill that slopes outwards. Two run-off bores  $\varnothing$  8 mm allow penetrating water to flow again off.

- From the outside, mount the upper and lower gusset plates on the rear frame. These must be glued and riveted using MD150041 rivets. Before bonding, clean with Sika Remover 208 and treat with Coating Activator after approx. 10 sec. flash-off time. After a flash-off time of approx. 15 min. you can bond.

**Note:** Always be wiped in one direction. Use a clean side of the tissue after each wipe. Clean the adhesive surface until no residue is visible on the cleaning cloth. Squeeze some adhesive out of the static mixer. Discard the first 20-30 cm of adhesive, as the mixture is not yet homogeneous. Now shorten the mixer for the desired application quantity, the last heel of the static mixer must remain, otherwise it will be destroyed.

- Press the gussets against the respective corner and rivet them in place.

### 2.2 Installation of guide rails, spring shaft and striker plate

- Place the **vertical guide rails** flush in the angles of the corner pillar. Align their top edge with the dimension from the installation drawing. Below there remains approx. 10 mm open space to the sill. The vertical guide rails must indicate the same location and separation distance to the roof so that the horizontal rails have the same height.
- Mount the guide rails absolutely parallel and in rectangular form on the shutter sill. Check this by matching the diagonal dimensions.
- Fix the guide rails with rivets MD150031  $\varnothing$  4,8 mm.

**Tip:** A seal seam through a 1K PU sealant compound e.g. Sikaflex prevents the intrusion of water between frame column and guide rail.

- Position the **horizontal guide rails** at an angle of 90° to the vertical guide rail (see Fig. 2.2.1 & installation drawing) in extension of the radius and parallel to the roof.
- For a sufficiently long gate runout, install the horizontal guide rail as far as possible in the length supplied. Then the gate does not impact the end stops. If you must shorten the rails for reasons of space, then place on a suitable stop with a shock absorber. The guide rail pairs are parallel and are to be installed at the same separation distance from each other.

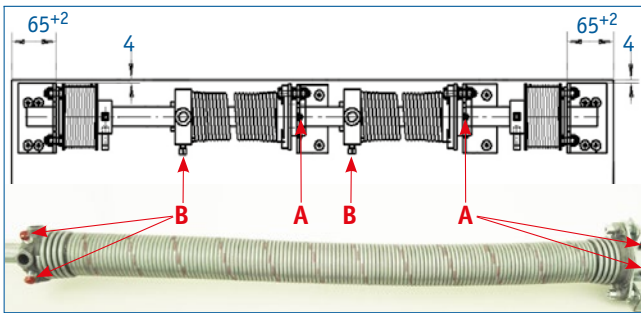



Fig. 2.2.2

- Likewise fix the horizontal guide rails similar to the vertical guide rails. Note a flat transition of both rails, otherwise the running rollers snag here. If required, the transition is to be reworked.
- To **install the spring shaft** (Fig. 2.2.2) first rivet the outer brackets (MD150041) rightangled or parallel to the rear frame. The right-angled or parallel arrangement is necessary because otherwise the roller shutter will run sluggishly.

Then place the spring shaft in the brackets and tighten the bearing shells on both sides.

**Attention:** On the cable reels there is either a **L** or an **R**. Install the reel with the **R** on the driver's side (Fig. 2.2.5)!

**Exkursus:** The spring shaft is prestressed with a force of approx. 80 kg. You may not loosen the setscrews (A) on the spring brackets until after the installation of the spring shaft when both ropes fit properly tight on the cable reels. The set screws (B) on the spring heads are used for post-tensioning only.

 An uncontrolled loosening of the set screws and spring brackets or spring heads relaxes the spring suddenly and can lead to injuries! **To loosen the set screws the spring head through the inserted tension rod before hand.** (Fig. 2.2.6).

- Loosen the set screws of the cable reel and align the spring shaft so that both shaft ends are at the same separation distance from the bracket support. Shift the cable reel outwards against the corresponding bracket support and retighten the set screws lightly.
- The two inner spring supports must now be at the correct position behind the door lintel. Underlay the brackets in order to avoid any possible deforming of the shaft. The shaft may not sag! Fix the middle spring supports securely through welding, screwing or riveting to the lintel.
- If the springs are not prestressed or loosened unintentionally, at least 100 mm separation distance must remain between the rotating spring head and the next-to the following part on the spring shaft, since the spring extends in length during later fixing. Slide the spring elements on the shaft as appropriate. Rotating and static parts may not touch each other.

## 2.3 Assembly of the panels

- Place the panels into the structure so that the top panel with the top sealing is located below. The articulated link seal must be fixed-located on the panel (Fig. 2.3.1) in this case, and the V-shaped sealing lip on the profile section edge.
- If this not the case, press the sealing lip back lightly onto the seal until you feel a definite latching engagement.
- Slide the running rollers into the plastic sockets. The rollers for the uppermost panel (top panel) are inserted into the double roll brackets where two rolls per side are employed here (Fig. 2.3.2).



Fig 2.2.3



Fig. 2.2.4

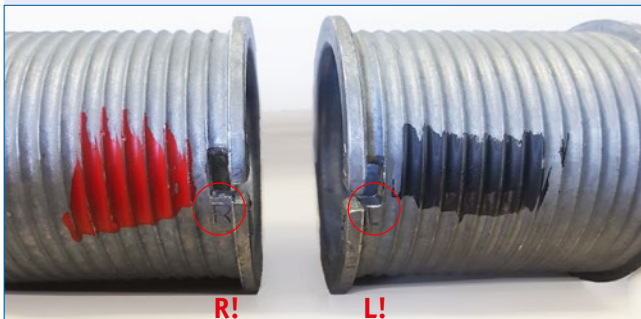

Fig. 2.2.5

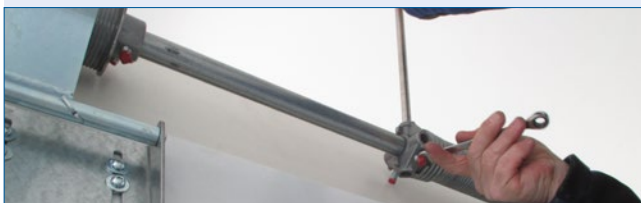

Fig. 2.2.6

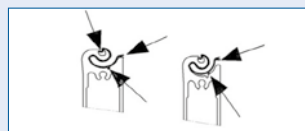

Fig. 2.3.1

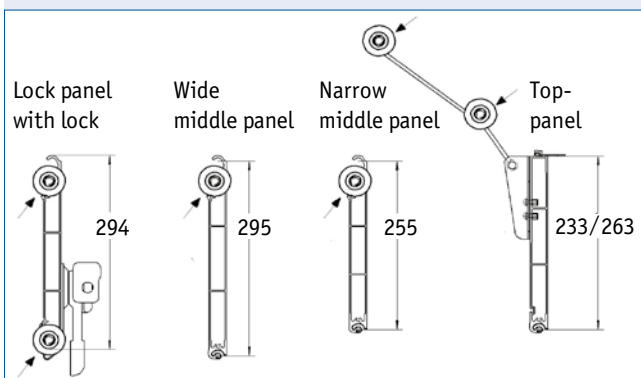

Fig. 2.3.2

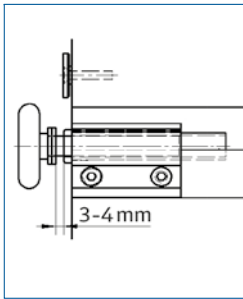

Fig. 2.3.3

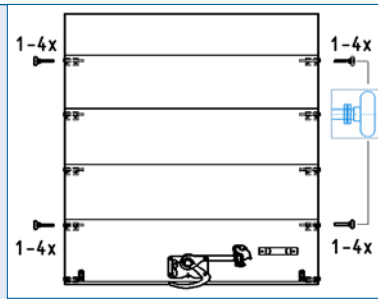

Fig. 2.3.4

- In order to balance tolerances in the rail separation (max. + 5 mm), underlay the marked rollers with 1 to 4 underlay washers (Fig. 2.3.3). The rolls must still have another 3 - 4 mm play at the narrowest location in the rail.

**Caution:** As a result of the underlay washers, the gate remains fixed at right angle to the guide rail (Fig. 2.3.4). It does not wander or roam on the rail and lasts longer. If you do not mount the washers, the thrust rings can be damaged.

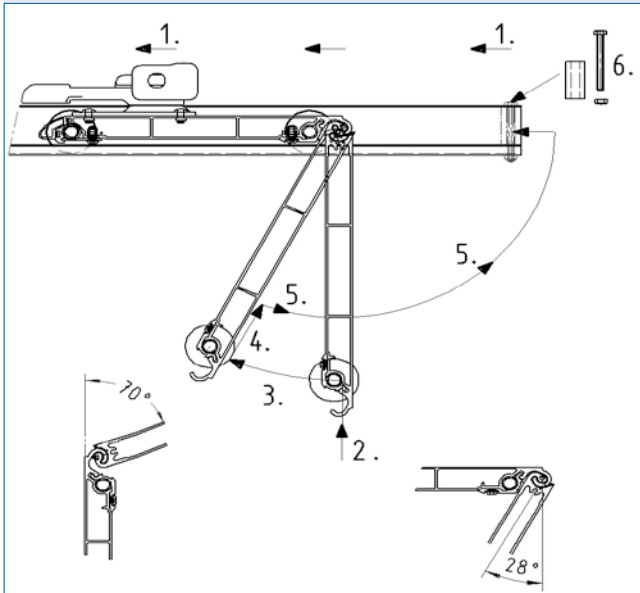

Fig. 2.4.1

## 2.4 Hang the shutter into the guide rails

- Guide the floor panel with the running rollers into the rails, the lock faces towards the roof, the floor sealing points towards the door opening. Slide the panel approx. 1 m into the rail and secure it against unintentional rolling away.
- Take a middle panel with inserted running rollers and washers, where these are prescribed, and press this upwards until the slot of the hinge engages into the hooks of the panel located in the rail. Hold the rollers with the open hook side down for opening the door (Fig. 2.4.1). **The panels may not indicate any side misalignment, so that the articulated link can be joined without any problem.**
- Slope the panel slightly in the door opening direction (approx. 28°). Slide the panel under this angle upwards.
- Rotate the panel into the horizontal and slide it into the rail.
- Repeat these procedures for all middle panels.
- Slide the partially assembled door to the end of the rail and hang the top panel in the same way as the other panels.
- After the folding up, introduce the double rolls into the rails. **If the panels cannot be folded up free-running then the hinge connection is not threaded correctly or is damaged.** Never fold up the panel with force, otherwise you can damage the seal! This fault mostly occurs when a panel side is folded up too early before the hook latches correctly into the slot.
- Now adjust the top panel. Loosen the four screws of the guide guide plate and move it vertically until the top panel is flush with the roller shutter. The guide plate must be aligned at right angles to the upper edge of the panel! If the guide plate is mounted at an angle, the rollers will be unnecessarily loaded.

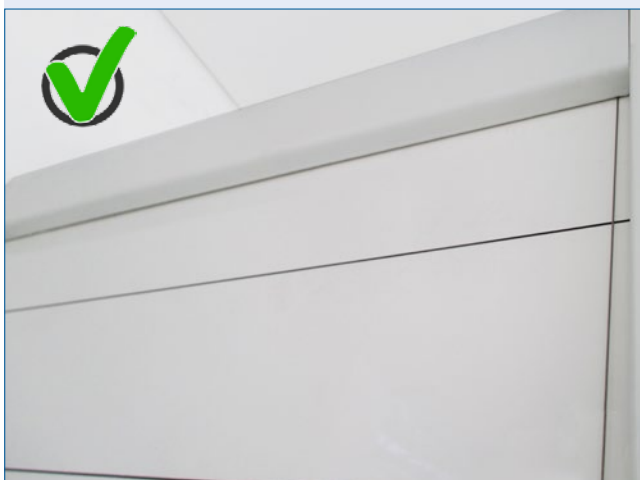

Fig. 2.4.2

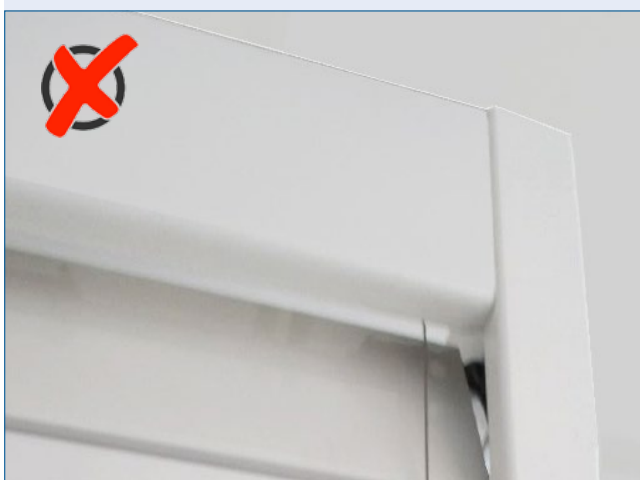

Fig. 2.4.3

If the top panel is at a 90° angle to the roller shutter, there is no air gap between the rear frame and the panel (Fig. 2.4.2). If an air gap is visible, the top panel is incorrectly adjusted (Fig. 2.4.3).

- Mount the limit stops at the end of the horizontal guide rail with the bolts supplied and slide the roller shutter carefully down into the vertical position.

**Caution:** The gate wing has a weight of approx. 90 kg and is not yet spring-supported. Only experienced fitters should implement the lowering of the gate. The force of the gate becomes increasingly greater the further you slide the gate into the vertical!



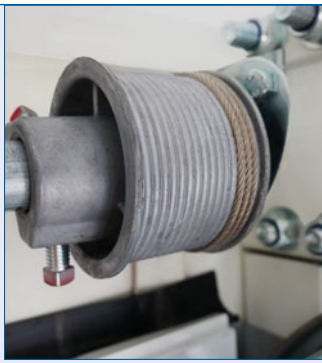

Fig. 2.5.1

## 2.5 Placing on the rope, adjusting the roller wheel brackets

- Loosen the two set screws of the left cable reel and coil the hook ed-in rope. It must be located exactly in the screw-thread shaped grooves of the drum. Rotate the reel until the rope is tightly tensioned and forms a vertical line (Fig. 2.5.1).
- Slide the cable reel against the support of the rail bracket and tighten both setscrews securely on the reel so that any slipping on the shaft is excluded. Repeat this procedure on the right-hand side.



**Caution:** The cable reels must be located fixed on the flanged bearings. The ropes must have the same tension and be located exactly in the trace grooves of the cable reel.

- Check the stretching behaviour of the ropes when the roller shutter is closed. Pull the ropes in the middle. If the rope gives way too much, tighten it. If the rope is only slightly stretched, it is taut enough. To tighten the rope, loosen the screws on the rope reels and turn the reel until the rope is taut and does not sag. Tighten the screws and check again.
- To prevent the rope from jumping over at the rope reel (Fig. 2.5.1), it must unwind towards the centre of the rear frame. If the rope unwinds at a 90° angle, it will jump over. When the roller shutter is closed, the rope runs at a slight angle < 90° from the upper edge towards the centre of the rear frame (Fig. 2.5.2).

- After the ropes are fixed correctly, please loosen the 4 grub screws (A - compare Page 9, Abb 2.6.5), on the spring brackets of the prestressed spring shaft. Hold the roller shutter on the upper panel while you are loosening the fourth bolt, in order to prevent an uncontrolled upward movement of the gate in case of a possibly too strongly stressed spring.

The grub screws remain (unscrewed far enough) in the brackets for the fixing of the spring shaft in case of possible repairs.

- Remain in the super structure and interlock the shutter with the lock. Adjust the upper double roll brackets until the upper panel is in a straight vertical line with the remaining gate segments. Then tighten the screws securely.
- Loosen the screws of the guide plate F for readjustment. Move it vertically until the top panel is flush with the door (Fig. 2.5.3). The guide plate must be aligned at right angles to the top edge of the panel. If the guide plate is mounted at an angle, the rollers will be too heavily loaded. Then tighten the screws firmly.

## 2.6 Adjusting the spring force

- **Check the function of the spring shaft**, by opening and closing the roller shutter. It should stay in the horizontal when it is approx. 1 m opened. If it lowers again, the spring force is too weak and the spring tension must be increased. If it lifts up by itself the spring force is too strong and you must reduce the spring tension.

**The roller shutter is optimally adjusted when it is in balance and when it is pushed upwards for a short time, it pulls up by itself.**

**Caution:** If the roller shutter is pushed up forcibly, the spring shaft works faster than the cable drums. As a result, the panels move faster than the ropes on the drums wind up correctly. In the worst case, the ropes skip and break. Point out to your customer to handle the panels properly!



Fig. 2.5.2

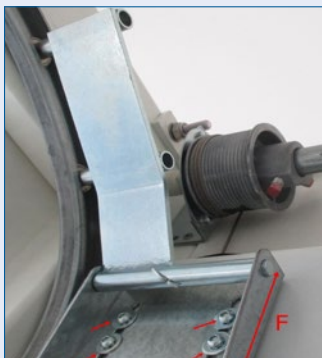

Fig. 2.5.3



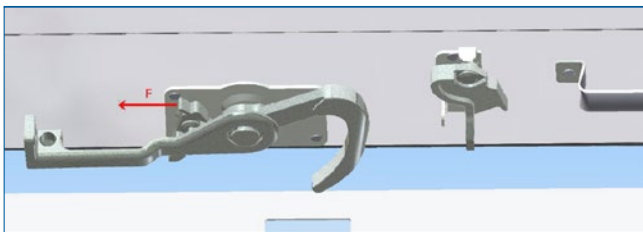

Fig. 2.6.1

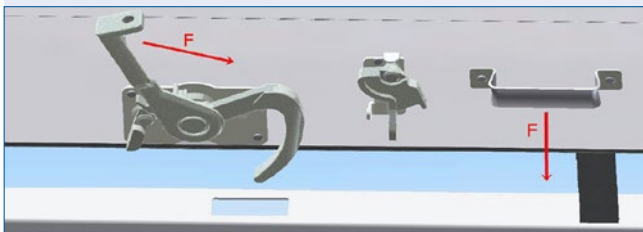

Fig. 2.6.2

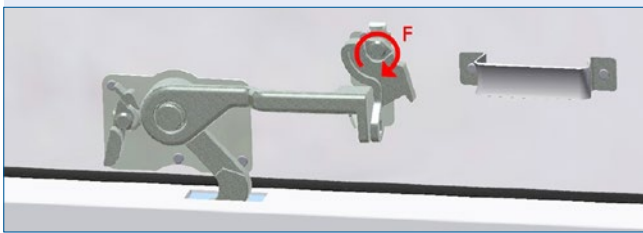

Fig. 2.6.3

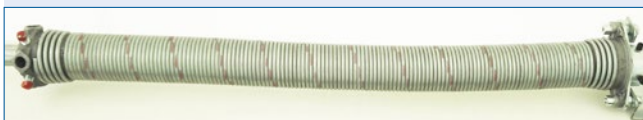

Fig. 2.6.4



Fig. 2.6.5

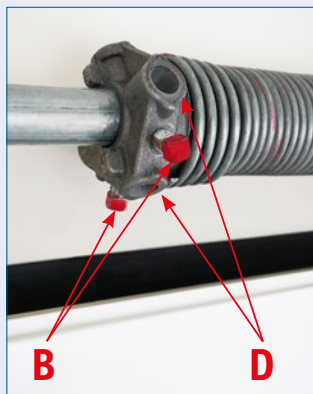

Fig. 2.6.6



Fig. 2.6.7



Fig. 2.6.8

- Before adjusting the spring force, lock the shutter. First loosen the locking pin of the locking fork (Fig. 2.6.1) and turn it until the hook is over the closing opening. Use the handle to push the roller shutter downwards (Fig. 2.6.2).

- Guide the locking hook into the closing opening and lock the locking fork again with the second locking pin (Fig. 2.6.3).

**Tip:** The spring tension is also indicated by the spiral red markings (Fig.2.2.2). The spring tension increases with the number of turns you see. Many markings mean a high spring tension. If you receive an untensioned spring, you can draw a horizontal line across the entire spring with white chalk to read off the number of turns. Alternatively, you can divide the height of the roller door leaf by 250 mm and add 3 turns. **Example:** Door height 2,125 mm:  $250 \text{ mm} = 8.5 + 3 = 11.5$  i.e. 12 revolutions. The spring force should be set the same for both springs (indicative value 11-12 visible spirals) to ensure optimal load sharing.

- To **adjust the spring force** first tighten the grub screws **A** of the spring shaft firmly to fix the shaft (Fig. 2.6.5).

- Now insert a tensioning rod into an accessible hole **D** of the rotating spring anchor and loosen the set screws **B** (Fig. 2.6.6). Hold the tensioning rod very securely, because it will now be loaded with the whole spring force.



**Caution:** Employ only solid (steel) clamping bars  $\varnothing$  13 mm, 450 mm long Screwdrivers or wedge-shaped rods are unsuitable and can lead to injuries!

- To increase the spring tension (Fig. 2.6.7) turn the tension rod clockwise. Use a second tension rod as a fixation. 2-3 quarter turns are sufficient.

- To reduce the spring tension (Fig. 2.6.8) turn the tension rod counterclockwise.

- Now tighten the set screws **B** (Fig. 2.6.6) again, and loosen the grub screws **A** (Fig. 2.6.5) on the spring shaft.

- Check the readjustment as described at the beginning of this chapter (2.6). described. If necessary, readjust the spring force.

### 3. Finishing work



Fig. 3.1

Hammer in seal with a piece of wood

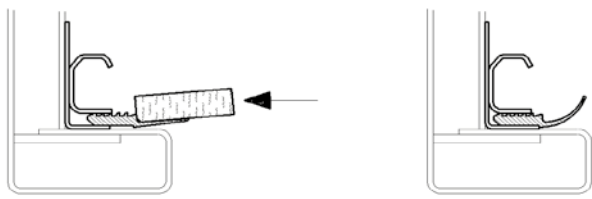

Fig. 3.2

- **Now install the two side seals.**
- Shorten these to the dimension of the transition height + 20 mm.
- Open the shutter and slide the (Fig. 3.1) down directly onto the sill, beginning in the gap between the vertical guide rail and the rail angle.
- Press in the seal by placing a wood piece onto the location of the seal provided for that and hammering this securely into its seating over the whole length (Fig. 3.2).
- Fix the upper end of the side sealing with a bolt or riveting on the lintel.

**Tip:** Increase the level of the sealing of the roller shutter by bonding the lower edge of the side sealing to the sill.

- For the **first lubrication** use a light, standard, penetrating oil in the spray can. Oil by light spraying at the following locations:

Upper roller holder, running roller, spring shafts and springs over the entire length, articulated link pin of the lock and lock protection.

- **Check** whether **all four seals** fit correctly (Fig. 4.1). Check in particular the tightness at the seal joint on the left and right. Bond the vertical seal with the sill. **Treat all seals** with commercially available rubber care spray that is free of silicones, such as Würth 0890110.
- Check whether **the ropes are evenly tensioned and are correctly wound on the reel**. An uneven tensioning leads to a higher level of wear of the roller shutter and premature failure because a rope can jump from the cable reel.
- Check whether all four **set screws of the two cable drums are tightened securely**. If a cable reel were to race on the spring shaft, the roller shutter will jam and must be repaired.
- Check whether **the inspection instructions are attached** on the floor panel inside or on the side wall inside.
- **Note the identity number** on the rating plate of the shutter. Attach this to your documents for later spare part procurement.
- For the **final control** check of the assembled rolling gate, open and close the roller shutter 5 to 6 times. It must run easily and not snag. The lock must be capable of being closed with normal pressure.

## 4. Maintenance, service, spare parts



- **To maintain the roller shutter**, check all parts for secure fastening at regular intervals, but at least once a year. Loose fastenings must be tightened or replaced.
- Check the **webbing, pull ropes, running rollers and hinges**. In case of damages replace them immediately!
- The ropes must be evenly tensioned and lie correctly on the reel windings. Uneven tension leads to higher wear of the roller shutter and premature failure because a rope can jump off the reel..
- **Oil** the lock, rollers, bearings, hinges, rails and the spring shaft with light penetrating oil. If they are not oiled, they will rust solid.
- **Treat all seals** with commercially available rubber care spray that is free of silicones, such as Würth 0890110.
- **Lost or damaged safety instructions** must be replaced. Never paint over safety instructions!

### Our Service:

You will receive fast support for questions regarding assembly:

**Tel.: +49 (0)521-41 73 11-30, E-Mail: [m.wismueller@aluteam.de](mailto:m.wismueller@aluteam.de)**

- Only use original AluTeam spare parts. **On our website you will find a current spare parts list.** Spare parts can be ordered either from your designated sales representative or:

**Tel (0)521-41 73 11-30,**

**E-Mail: [m.wismueller@aluteam.de](mailto:m.wismueller@aluteam.de)**



## 5. Disposal of worn-out parts



All component parts can be delivered as scrap **for recycling**.

## 6. Copyright

The copyright of these instructions belongs to AluTeam. They are only intended for the professional installation company and its staff, and its contents may not, either completely or in part, be:

- Duplicated
- Distributed or
- Communicated in any other manner.

***Infringements may result in civil and criminal penalties!***

## 7. Installation drawing DP25 HR

